



# Installation Instructions Safari Style Sun Bikini Top

**Vehicle Application:**  
Jeep® Gladiator 2020-Current  
Part Number 52413

## Installation Tips

Before you begin installing your new Safari Style Sun Bikini Top, please read all the instructions thoroughly.

**WARNING** Do not rely in any way on the components of this product to protect against injury or death in the event of an accident. Never operate the vehicle in excess of manufacturer's specifications.

Read and follow, precisely, all installation instructions provided when installing this product. Failure to do so may result in a poor fit and could place occupants of the vehicle in a potentially dangerous situation.

## WEAR SEAT BELTS AT ALL TIMES

**CAUTION** Safety glasses should be worn at all times when installing this product.



### Tools



Safety Glasses



T25 Torx Driver

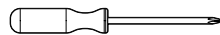

Phillips Screwdriver

### Installation Time



30 minutes

### Skill Level



1 - Easy



## Installation Instructions Safari Style Sun Bikini Top

Vehicle Application:  
Jeep® Gladiator 2020-Current  
Part Number 52413

### Sugerencias de Instalación

**Antes de empezar a instalar esta unidad, lea atentamente todas las instrucciones.**

**Para un buen ajuste:**

Para facilitar la instalación, el producto debe instalarse a temperaturas superiores a 72 °F (22 °C).

Por debajo de esta temperatura, la tela puede encogerse una pulgada o más, lo que dificultaría su ajuste al vehículo.

Es normal que la tela se contraiga o arrugue cuando está guardada en la caja de empaque. A los pocos días después de la instalación, la tela se relajará y las arrugas desaparecerán.



#### ADVERTENCIA

Este producto se diseñó principalmente para mejorar la apariencia del vehículo y proteger a los ocupantes de las condiciones climáticas comunes. De ninguna manera piense que los componentes de este producto pueden servir como medio de contención para los ocupantes del vehículo o que pueden protegerlos contra lesiones o la muerte en caso de accidente. Este producto no protegerá a los ocupantes contra caídas de objetos. Nunca conduzca este vehículo fuera de las especificaciones del fabricante.

#### USE LOS CINTURONES DE SEGURIDAD EN TODO MOMENTO

Lea y siga con precisión todas las instrucciones de instalación que se proporcionan para instalar este producto. Si no lo hace, podría producirse un mal ajuste que colocaría a los ocupantes del vehículo en una situación potencialmente peligrosa.



#### PRECAUCIÓN

Debe usar gafas protectoras en todo momento durante la instalación de este producto.

### Conseils pour l'installation

**Lire toutes les instructions au complet avant de commencer l'installation de cet assemblage.**

**Pour un ajustement sans problème :**

Afin de faciliter l'installation, ce produit doit être installé à des températures au-dessus de 72 °F (22 °C).

Sous cette température, le tissu peut rétrécir d'un pouce (2,5 cm) ou plus, ce qui rendra l'ajustement sur le véhicule difficile.

Il est normal que le tissu rétrécisse et plisse pendant qu'il est dans la boîte d'expédition. En quelques jours après l'installation, le tissu se détendra et les plis disparaîtront.



#### AVERTISSEMENT

Ce produit est conçu principalement pour améliorer l'apparence du véhicule et pour protéger les occupants des conditions météorologiques usuelles. Ne jamais se fier aux composants de ce produit pour se protéger de blessures ou de la mort en cas d'accident. Ce produit ne protégera pas les occupants des chutes d'objets. Ne jamais utiliser le véhicule au-delà des caractéristiques techniques indiquées par le fabricant.

#### PORTER UNE CEINTURE DE SÉCURITÉ EN TOUT TEMPS

Lire et suivre, très fidèlement, toutes les instructions d'installation fournies lors de l'installation de ce produit. Ne pas suivre cette consigne peut causer une installation inadéquate et mettre les occupants du véhicule dans une situation potentiellement dangereuse.



#### MISE EN GARDE

Des lunettes de sécurité doivent être portées en tout temps lors de l'installation de ce produit.







# Installation Instructions Safari Style Sun Bikini Top

Vehicle Application:  
Jeep® Gladiator 2020-Current  
Part Number 52413

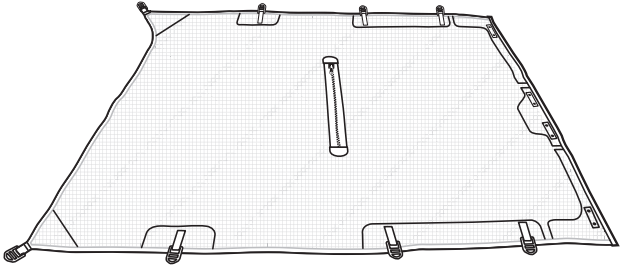
## Parts List

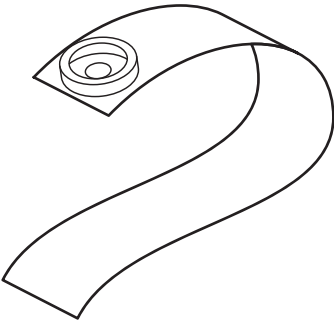
- Required parts for installation      - Page number in Installation Guide

Sections 1 to 5	Top, Snap Stud Screws, Snap Straps		Pages 4 to 9 of Guide
 <p>Safari Style Sun Bikini Top Qty. 1</p>	 <p>Snap Stud Screw #8x5/8" Part #728221 Qty. 8</p>	 <p>Snap Straps Varying Lengths Qty. 8</p>	 <p>Tail Clip Part #338.24 Qty. 8</p>

## Step 1

## Hardware

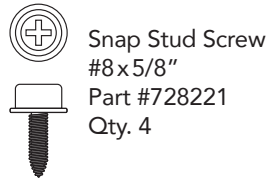

## Tools



T25 - Torx Driver

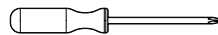

Phillips Screwdriver

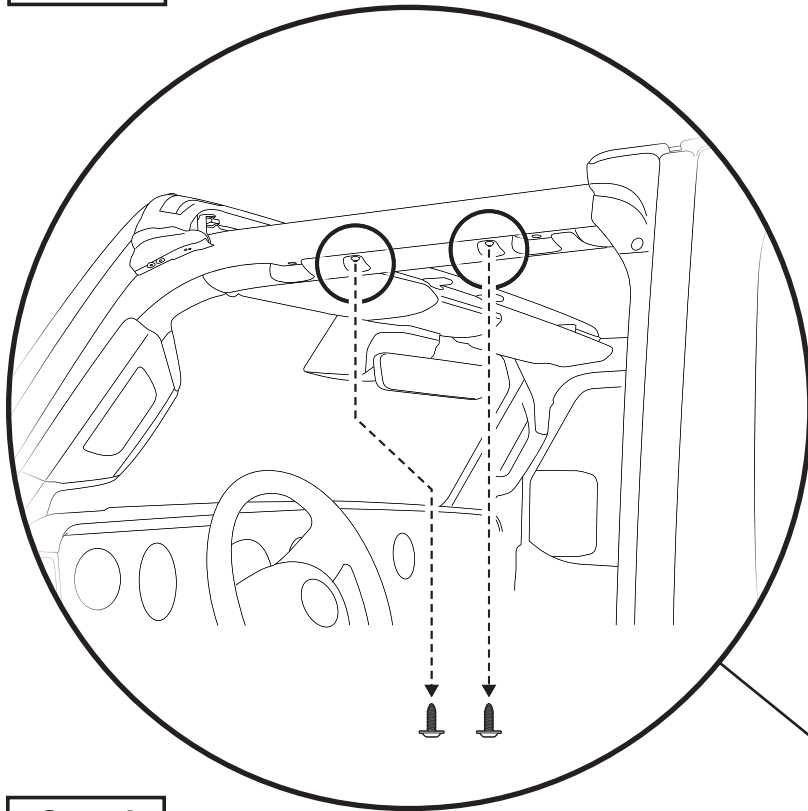

## Step 1

Remove the two Torx screws from the underside of the front sport bar in the locations shown.

Left (driver) side shown. Remove these four screws on both sides of the Jeep.

Replace the screws you removed with Snap Stud Screws #728221 in all four locations.



**Step 1**

**Hardware**

**Step 2**

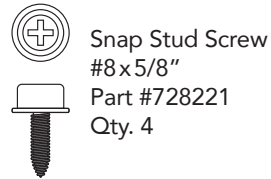
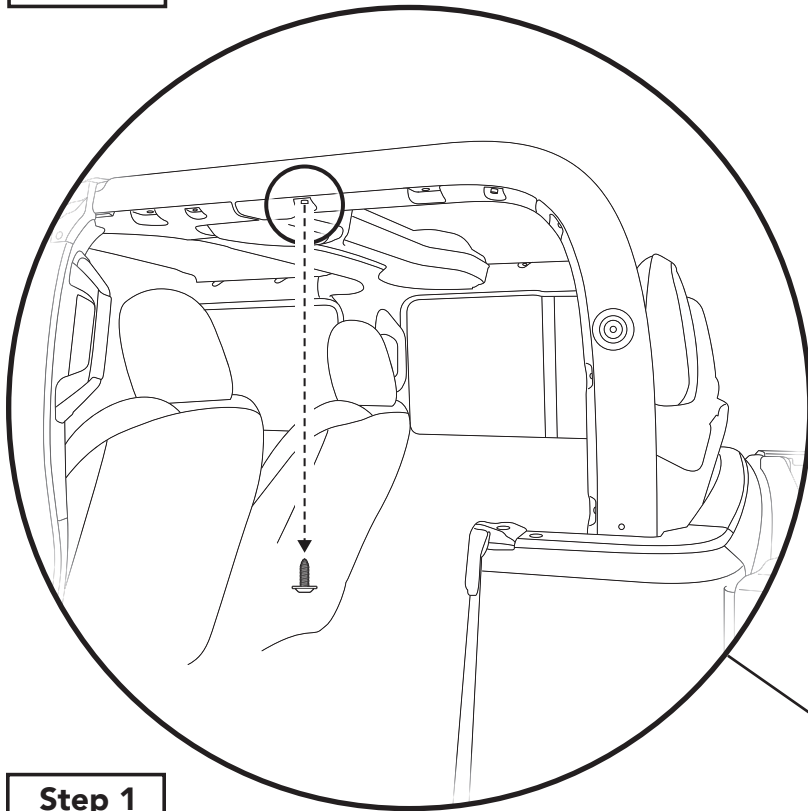

**Tools**



T25 - Torx Driver

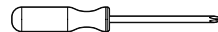

Phillips Screwdriver

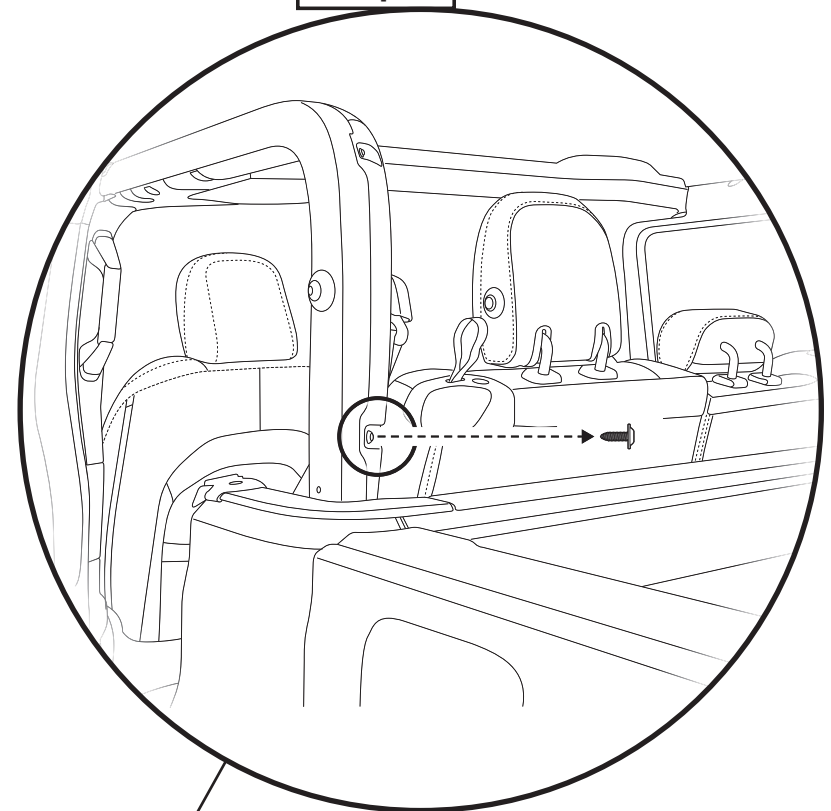

**Step 1**

Remove the Torx screws from the underside of the rear sport bar in the locations shown.

Left (driver) side shown. Remove this screw on both sides of the Jeep.

Replace the screws you removed with Snap Stud Screws #728221 in both locations.

**Step 2**

Remove the Torx screw from rear sport bar downtube as shown. Left (driver) side shown.

Remove this screw on both sides of the Jeep.

Replace the screws you removed with Snap Stud Screws #728221 in both locations.

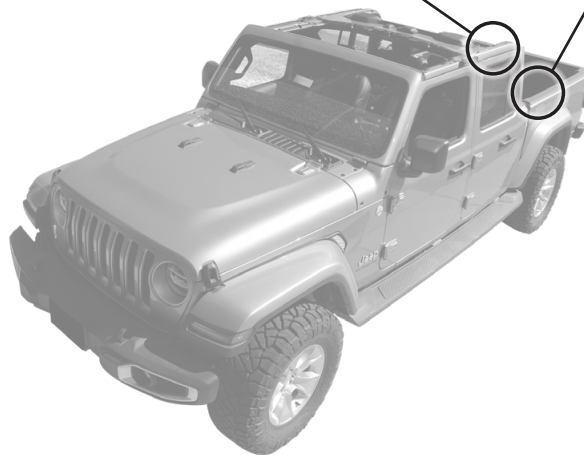

**Step 1**

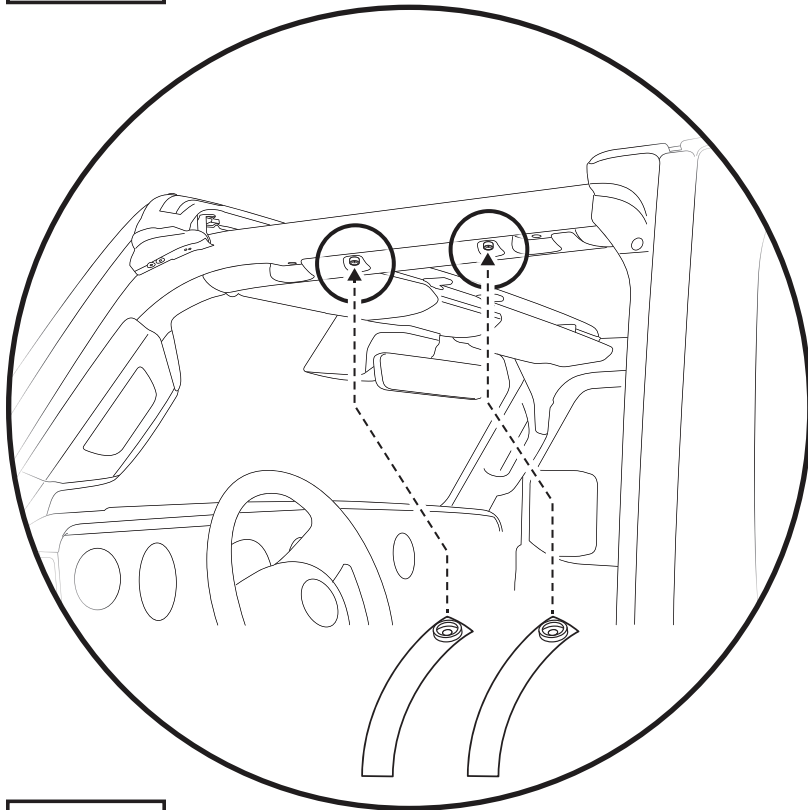

**Hardware**



Short Snap Straps  
Qty. 6

**Step 2**

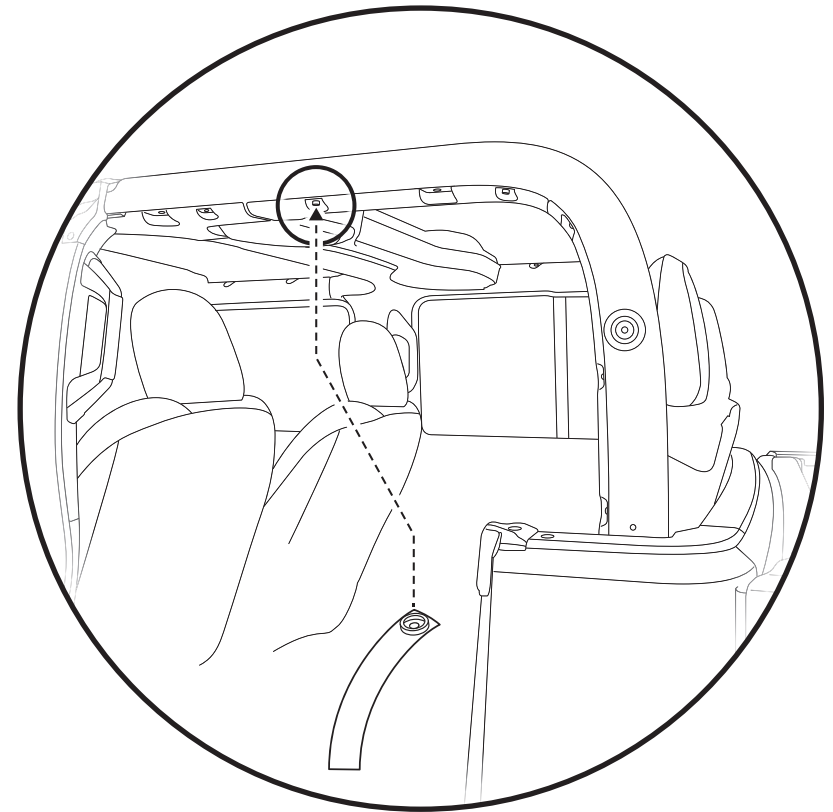

**Step 1**

Attach the shorter Snap Straps to the Snap Studs in the four front sport bar locations - two on each side of the Jeep.

Straps should be positioned so that the straps hang to the outside of the Jeep.

Attach the longer Snap Straps to the Snap Studs in the four (4) rear sport bar locations - two on each side of the Jeep. (Safari Top Only)

Straps should be positioned so that the straps hang to the outside of the Jeep.

**Step 2**

Attach two Snap Straps to the Snap Studs in the two rear sport bar locations - two on each side of the Jeep.

Straps should be positioned so that the straps hang to the outside of the Jeep.

**Step 1**

**Hardware**

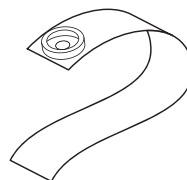
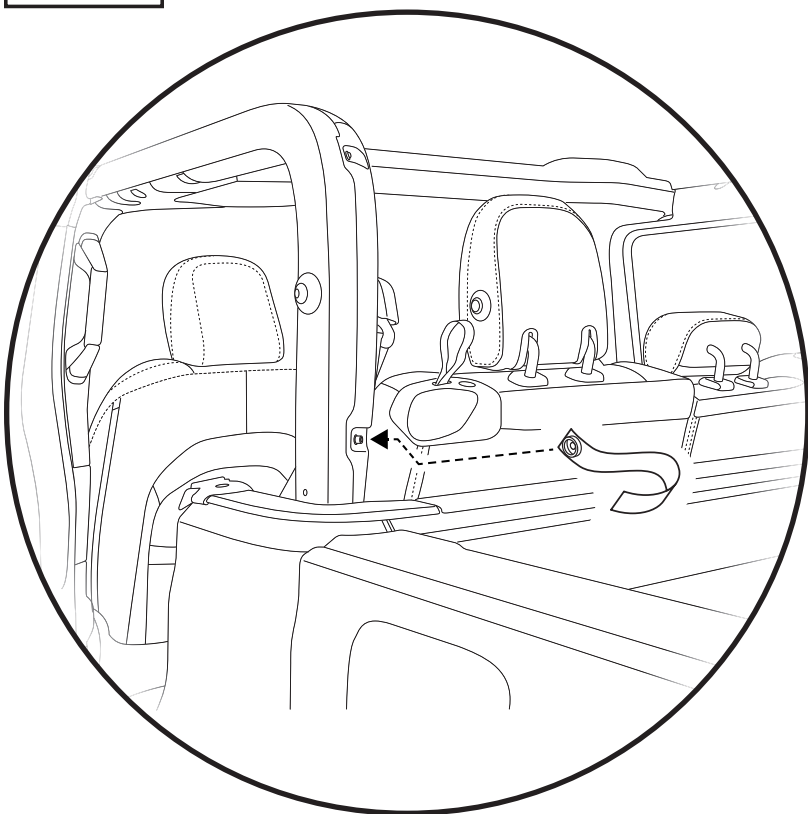

Long Snap Straps  
Qty. 2

**Step 1**

Attach two Long Snap Straps to the Snap Studs in the two rear sport bar downtube locations shown - one on each side of the Jeep.

Straps should be positioned so that the straps hang to the outside of the Jeep.

**Step 1**

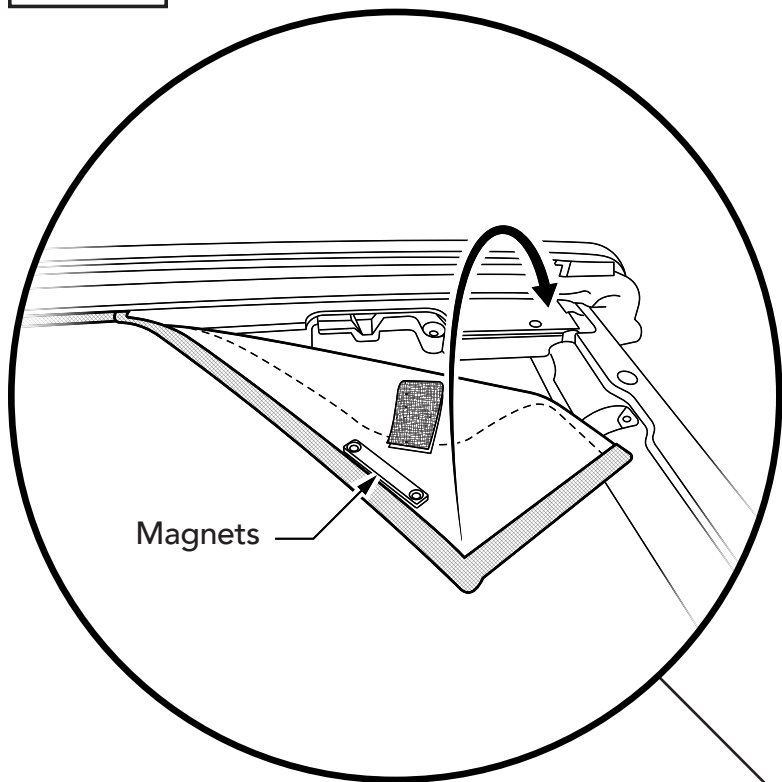

**Hardware**

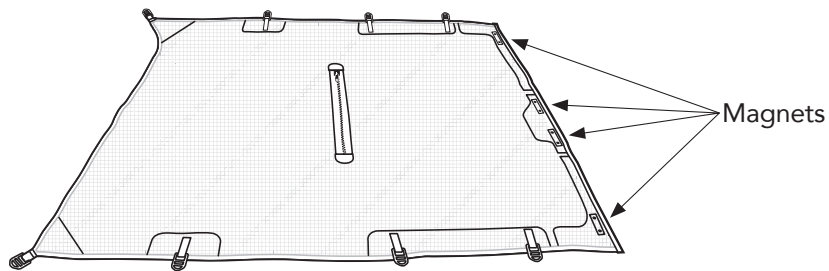

Safari Style Sun Bikini Top

**Step 1**

Lay the Sun Bikini on top of the Jeep, with the magnets at the front, and the long corner straps at the rear.

Place the Bikini so that the magnets come into contact with the metal part of the windshield header that is the same height as the top of the sport bar.

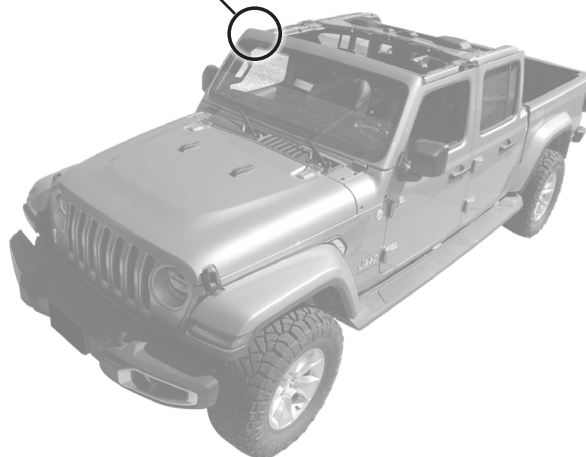



**Step 1**

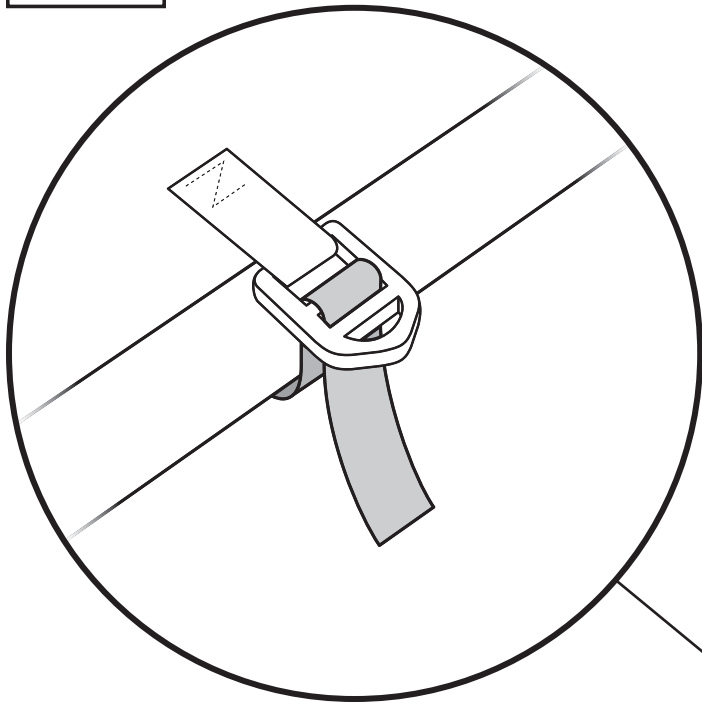

**Hardware**



Tail Clip  
Part #338.24  
Qty. 10

**Step 2**

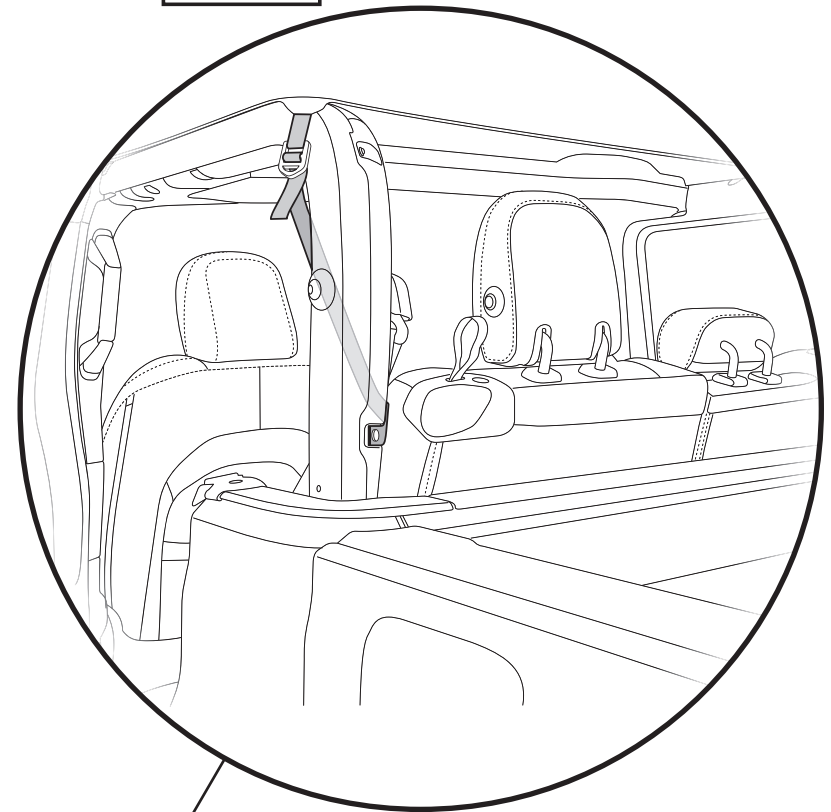

**Step 1**

Attach the eight straps loosely to the buckles in the manner shown.

**Step 2**

Wrap the rear (long) straps around each rear sport bar downtube as shown.

Each strap will go to the interior side of the Jeep, wrapping underneath the downtube, and attaching to the buckle at the rear corner of the top.

Now snug all of the straps, starting with the front two, then the rear two, then the four in the middle of the Jeep.

Dress the loose ends of the straps with the Tail Clips, #338.24.

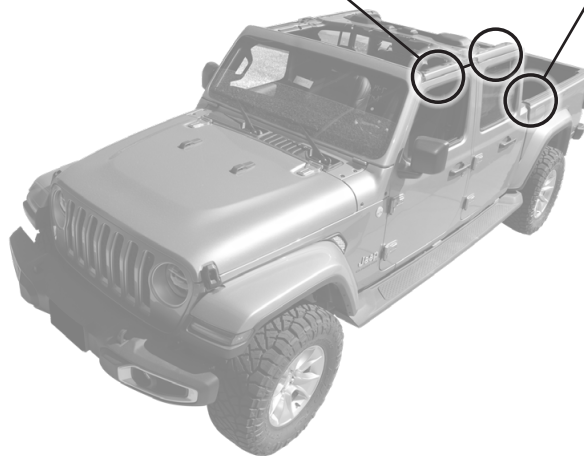



## Warranty Information Safari Style Sun Bikini Top

Vehicle Application:  
Jeep® Gladiator 2020-Current  
Part Number 52413

### WHAT BESTOP WARRANTS

Subject to the terms and conditions of sale, including any terms and conditions set forth by Bestop, Inc. (“Bestop” or “us” or “we”) in our then-current terms of sale on our website (collectively, the “Terms”), Bestop represents and warrants that: the covered products listed in the “Covered Products and Warranty Periods” section (a “Product”) will substantially be free from defects in materials and workmanship for the specified warranty periods set forth in that section.

### THE WARRANTY IS LIMITED AND CONDITIONAL

This warranty applies to the original purchaser of the Product only. The warranty is valid only as long as the original retail purchaser owns the vehicle upon which the Product is installed. The warranty expires should the Product be removed from the original vehicle or if the original vehicle is transferred to another owner.

This warranty is not transferable or assignable. The warranty does not apply to Product bought from auction-style or price-bid websites.

THE LIMITED WARRANTY AND STATED REMEDIES ARE SOLE AND EXCLUSIVE AND IN LIEU OF ALL OTHER WARRANTIES AND REMEDIES, AND COMPANY EXPRESSLY DISCLAIMS ALL IMPLIED OR STATUTORY OR OTHER WARRANTIES, INCLUDING WITHOUT LIMITATIONS WARRANTIES OF MERCHANTABILITY, NON-INFRINGEMENT OR FITNESS FOR A PARTICULAR PURPOSE. IN NO EVENT WILL COMPANY BE LIABLE FOR ANY SPECIAL, INCIDENTAL, CONSEQUENTIAL, PUNITIVE, INDIRECT OR EXEMPLARY DAMAGES OF ANY KIND, INCLUDING LOST PROFITS OR REVENUE, HOWEVER CAUSED, WHETHER FOR BREACH OR REPUDIATION OF CONTRACT, TORT, BREACH OF WARRANTY, NEGLIGENCE, OR OTHERWISE, WHETHER OR NOT COMPANY WAS ADVISED OF THE POSSIBILITY OF SUCH LOSS OR DAMAGES.

*Some states do not allow exclusion or limitation, so this may not apply to you. This warranty gives you specific legal rights, and you may have other rights which vary from state to state.*

### EXCLUSIONS TO THE WARRANTY

The Limited Warranty excludes, and Bestop is not liable in any way for any warranty claims, damages, or defects related to:

- Misuse, abuse, accidents, vandalism, negligence, fire, or improper installation or modification, or improper or inadequate maintenance;
- Failure to comply with any Product documentation, Bestop instructions, or applicable law or regulations; use in extreme conditions
- Force Majeure including but not limited to, earthquake, hurricane, tornado, flooding, or other disasters natural or man-made, civil unrest, strikes, declared or undeclared war, or lack of performance by, or discontinued product of, supply chain partners whose products, software, operations or management is beyond the control of Bestop;
- Damage resulting in breakage (including without limitation, spontaneous breakage, accidental breakage or breakage by any other means) of a Product or any component part;
- Damage to vinyl windows due to misuse, or cracking due to varying weather conditions.



## Warranty Information Safari Style Sun Bikini Top

Vehicle Application:  
Jeep® Gladiator 2020-Current  
Part Number 52413

**COVERED PRODUCTS AND WARRANTY PERIODS:** The warranty time periods are as follows for Products manufactured by Bestop:

### **BESTOP® LIMITED LIFETIME WARRANTY**

Trektop® Pro Twill Fabric Top Sunrider® for Hardtop Twill Fabric Top  
Trektop® NX Glide Twill Fabric Top Replace-a-Top™ Twill Fabric Top  
Trektop® NX Twill Fabric Top Supertop® NX Twill Fabric Top  
EZFold™ Soft Tonneaus Floor & Cargo Liners  
ZipRail™ Soft Tonneaus Pet Barriers  
EZRoll™ Soft Tonneaus

### **BESTOP® 5-YEAR LIMITED WARRANTY**

Trektop® NX Glide™ Top (non-Twill) Sunrider® for Hardtop (non-Twill) Replace-a-Top™ Top (non-Twill) Trektop® NX Top (non-Twill)  
Sailcloth Replace-a-Top™ Supertop® NX Top (non-Twill)  
Tigertop™ and Halftop™ Supertop® Classic Soft Top Sunrider® Complete Soft Top Supertop® for Truck  
EZ Fold Hard Tonneau

### **BESTOP® 3-YEAR/100K MILES LIMITED WARRANTY**

Powerboard® & Powerboard® NX  
Trekstep®, Side Mount  
Trekstep®, Rear Mount

### **BESTOP® 3-YEAR LIMITED WARRANTY**

Pavement Ends Sprint Top

### **BESTOP® 2-YEAR LIMITED WARRANTY**

Trektop® Classic Soft Top  
RoughRider™ Soft Storage

### **BESTOP® 1-YEAR LIMITED WARRANTY**

All other Bestop® & Pavement Ends™ products not specified above.