

2020-2020 JEEP GLADIATOR JT 4 Inch Lift Kits INSTALLATION INSTRUCTIONS

Engineered for 4WD Models.

Fits: 2020 Jeep Gladiator JT Sport 4WD

2020 Jeep Gladiator JT Sport S 4WD

2020 Jeep Gladiator JT Rubicon 4WD

2020 Jeep Gladiator JT Overland 4WD

2020 Jeep Gladiator JT North Edition 4WD



CAUTION: MAKE SURE YOU HAVE THE CORRECT LIFT FOR YOUR VEHICLE:

Double check the Year, Make, Model, Lift Height and KIT Part Numbers.

NOTE: Prior to beginning the installation, OPEN the Boxes and CHECK the Included Components Compared to the Parts Breakdown. Check all parts and hardware in the box with the parts list below. Be sure you have all needed parts and know where they install.

If you find a packaging error, contact SUPERLIFT directly. Do not contact the dealer where the system was originally purchased. You will need the control number from each box when calling; this number is located at the bottom of the part number label and to the right of the bar code.

- ① Fixed Upper Link Arms - Rear
- ② Sway Bar End Links - Rear
- ③ Coil Spring - Rear - Passenger Side
- ④ Coil Spring - Rear - Driver Side
- ⑤ Bump Stop Bracket - Rear
- ⑥ Shock Relocation Bracket - Rear
- ⑦ Brake Line Bracket - Rear - DR. & PA. Side
- ⑧ Coil Springs - Front- Passenger Side
- ⑨ Sway Bar End Link - Front
- ⑩ Shock Relocation Bracket - Front
- ⑪ Coil Springs - Front - Driver Side
- ⑫ Fixed Lower Link - Front - Passenger
- ⑬ Fixed Lower Link - Front - Driver Side
- ⑭ Bump Stop Spacer - Front
- ⑮ Carrier Bearing Spacer - JT
- ⑯ Track Bar - Front - Adjustable



NOTE: K196 4 Inch Lift With Shock Relocation Brackets Shown

- ① Fixed Upper Link Arms - Rear
- ② Sway Bar End Links - Rear
- ③ Coil Spring - Rear - Passenger Side
- ④ Coil Spring - Rear - Driver Side
- ⑤ Bump Stop Bracket - Rear
- ⑥ FOX Shock - Rear - Jeep JT
- ⑦ Brake Line Bracket - Rear - DR. & PA. Side
- ⑧ Coil Springs - Front- Passenger Side
- ⑨ Sway Bar End Link - Front
- ⑩ FOX Shock - Front - Jeep JT
- ⑪ Coil Springs - Front - Driver Side
- ⑫ Fixed Lower Link - Front - Passenger
- ⑬ Fixed Lower Link - Front - Driver Side
- ⑭ Bump Stop Spacer - Front
- ⑮ Carrier Bearing Spacer - JT
- ⑯ Track Bar - Front - Adjustable

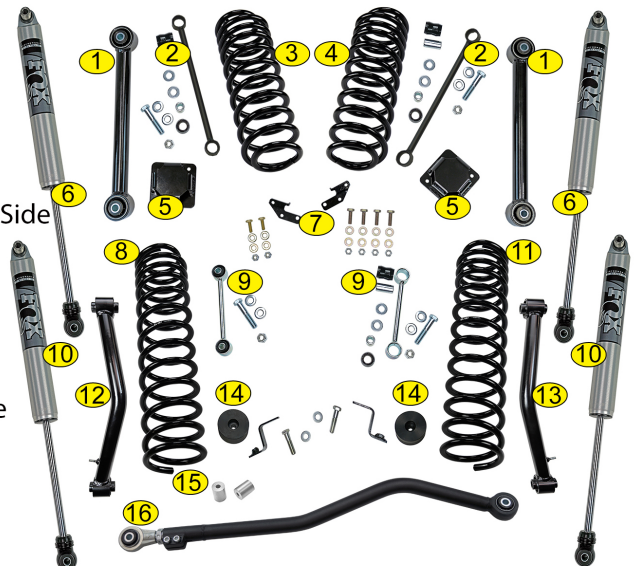

NOTE: K197F 4 Inch Lift With FOX Shocks Shown.

How to Read the Kit Breakdown Charts:

The 'K KIT BREAKDOWN' lists the Part Numbers, Quantities & Part Description of the Boxes that are included in the K KIT. The 'KIT BREAKDOWN' lists Part Numbers, Quantities & Part Description of the Individual Components & Hardware Bags that are included in Each Box. The 'HARDWARE BREAKDOWN' lists the Part Numbers, Quantities & Part Description of the Individual Components.

K KIT BREAKDOWN					
Kit Part Number K196			Kit Part Number K197F		
Part Number	Qty.	Part Description	Part Number	Qty.	Part Description
600	1	JT Coil Springs - 4 Inch - Front, Pair	600	1	JT Coil Springs - 4 Inch - Front, Pair
601	1	JT Coil Springs - 3 Inch - Rear, Pair	601	1	JT Coil Springs - 3 Inch - Rear, Pair
5834	1	Kit Box: JT Front with Shock Brackets	5835	1	Kit Box: JT Front Brackets
5836	1	Kit Box: JT Rear with Shock Brackets	5837	1	Kit Box: JT Rear Brackets
5831	1	Adjustable Track Bar - Front	5831	1	Adjustable Track Bar - Front
			84121	1	FOX Shock Box

KIT BOX BREAKDOWN					
Kit Part Number 600			Kit Part Number 601		
Part Number	Qty.	Part Description	Part Number	Qty.	Part Description
01-600	1	Coil Springs - Front - Driver Side	01-601	1	Coil Springs - Rear - Driver Side
02-600	1	Coil Springs - Front- Passenger Side	02-601	1	Coil Springs - Rear - Passenger Side
Kit Part Number 5831			Kit Part Number 84121		
Part Number	Qty.	Part Description	Part Number	Qty.	Part Description
66-23-5825	1	Track Bar - Front - Adjustable	985-24-177	2	FOX Shock - Front - Jeep JT
			985-24-220	2	FOX Shock - Rear - Jeep JT
Kit Part Number 5834					
Part Number	Qty.	Part Description	Part Number	Qty.	Part Description
55-19-5825	2	Sway Bar End Link - Front	66-11-5825	1	Fixed Lower Link - Front - Passenger Side
55-13-5825	2	Shock Relocation Bracket - Front	77-5834	1	Hardware Bag
55-17-5825	2	Bump Stop Spacer - Front	77-5834A	1	Hardware Bag
66-10-5825	1	Fixed Lower Link - Front - Driver Side			
Kit Part Number 5835					
Part Number	Qty.	Part Description	Part Number	Qty.	Part Description
55-19-5825	2	Sway Bar End Link - Front	66-11-5825	1	Fixed Lower Link - Front - Passenger Side
55-17-5825	2	Bump Stop Spacer - Front	77-5835	1	Hardware Bag
66-10-5825	1	Fixed Lower Link - Front - Driver Side	77-5834A	1	Hardware Bag
Kit Part Number 5836					
Part Number	Qty.	Part Description	Part Number	Qty.	Part Description
55-01-5830	1	Brake Line Bracket - Rear - Driver Side	66-06-5830	2	Fixed Upper Link - Rear
55-02-5830	1	Brake Line Bracket - Rear - Passenger Side	55-14-3310	2	Sway Bar End Link - Rear
55-03-5830	2	Bump Stop Bracket - Rear	77-5836	1	Hardware Bag
55-04-5830	2	Shock Relocation Bracket - Rear	77-5836A	1	Hardware Bag - Shocks & Sway Bar Links
77-5830	1	#55-05-5830 - Carrier Bearing Spacer - JT			
Kit Part Number 5837					
Part Number	Qty.	Part Description	Part Number	Qty.	Part Description
55-01-5830	1	Brake Line Bracket - Rear - Driver Side	66-06-5830	2	Fixed Upper Link - Rear
55-02-5830	1	Brake Line Bracket - Rear - Passenger Side	55-14-3310	2	Sway Bar End Link - Rear
55-03-5830	2	Bump Stop Bracket - Rear	77-5837	1	Hardware Bag
77-5830	1	#55-05-5830 - Carrier Bearing Spacer - JT	77-3413B	1	Hardware Bag - Sway Bar Links

HARDWARE BAG BREAKDOWN

Kit Part Number 77-3413B			Kit Part Number 77-5836		
Part Number	Qty.	Part Description	Part Number	Qty.	Part Description
24-5704	4	Sleeve, 0.750" x 0.500" x 1.535"	12X112C8CS	2	1/2" x 1-1/2" Bolt, Coarse Thread, Grade 8
01-60418	4	Poly. Hourglass Bushing, 0.075 x 1.44"	12SW	6	1/2" SAE Flat Washer
			12C5NN	2	1/2" Nyloc Nut, Course Thread, Grade 5
			12UW	4	1/2" USS Flat Washer
Kit Part Number 77-5830			Kit Part Number 77-5834		
Part Number	Qty.	Part Description	Part Number	Qty.	Part Description
55-05-5830	2	Carrier Bearing Spacer - JT	516C5NN	6	5/16" Nyloc Nut, Course Thread, Grade 5
			516SW	12	5/16" SAE Flat Washer
			516X1C8CS	2	5/16" x 1" Bolt, Coarse Thread, Grade 8
			516X114C8CS	4	5/16" x 1-1/4" Bolt, Coarse Thread, Grade 8
Part Number	Qty.	Part Description	Part Number	Qty.	Part Description
12C5NN	4	1/2" Nyloc Nut, Course Thread, Grade 5	916SW	4	9/16" SAE Flat Washer
12SW	8	1/2" SAE Flat Washer	916C5NN	2	9/16" Nyloc Nut, Course Thread, Grade 5
12X234C8CS	2	1/2" x 2-3/4" Bolt, Course Thread, Grade 8	916X312C8CS	2	9/16 x 3-1/2" Bolt, Coarse Thread, Grade 8
12X312C8CS	2	1/2" x 3-1/2" Bolt, Course Thread, Grade 8	10MFW	4	10mm Flat Washer
38C5FN	2	3/8" Flange Nut, Course Thread, Grade 5	10MX1.5X60CS	4	10mm x 60mm Bolt, 1.5, Grade 8.8
38SW	4	3/8" SAE Flat Washer	12MNN	2	12mm Nyloc Nut, 1.75 Coarse Thread
38X1C8CS	2	3/8" x 1" Bolt, Course Thread, Grade 8	12MX1.75X70CS	4	12mm x 70mm Bolt, 1.75, Grade 10.9
38X134C8CS	2	3/8" x 1-3/4" Bolt, Course Thread, Grade 8	Kit Part Number 77-5836A		
12MX1.75X80CS	2	12mm x 80mm Bolt, 1.75, Grade 10.9	Part Number	Qty.	Part Description
12MFW	4	12mm Flat Washer	#55-09-5830	2	Sleeve, 0.875" OD x 0.635" ID x 1.563" Long
12MNN	2	12mm Nyloc Nut, 1.75 Coarse Thread	24-5704	4	Sleeve, 0.750" x 0.500" x 1.535"
			01-60418	4	Poly. Hourglass Bushing, 0.075 x 1.44"
Kit Part Number 77-5834A			Kit Part Number 77-5837		
Part Number	Qty.	Part Description	Part Number	Qty.	Part Description
55-08-5800	2	Tab Nut: 3/8"	12SW	2	1/2" SAE Flat Washer
24-5704	6	Sleeve, 0.750" x 0.500" x 1.535"	12UW	4	1/2" USS Flat Washer
01-60418	4	Poly. Hourglass Bushing, 0.075 x 1.44"	516C5NN	6	5/16" Nyloc Nut, Course Thread, Grade 5
			516SW	12	5/16" SAE Flat Washer
Kit Part Number 77-5835			516X1C8CS	2	5/16" x 1" Bolt, Coarse Thread, Grade 8
Part Number	Qty.	Part Description	516X114C8CS	4	5/16" x 1-1/4" Bolt, Coarse Thread, Grade 8
12C5NN	2	1/2" Nyloc Nut, Course Thread, Grade 5	10MFW	4	10mm Flat Washer
12SW	4	1/2" SAE Flat Washer	10MX1.5X60CS	4	10mm x 60mm Bolt, 1.5, Grade 8.8
12X234C8CS	2	1/2" x 2-3/4" Bolt, Course Thread, Grade 8	12MNN	2	12mm Nyloc Nut, 1.75 Coarse Thread
38SW	2	3/8" SAE Flat Washer	12MX1.75X70CS	4	12mm x 70mm Bolt, 1.75, Grade 10.9
38X134C8CS	2	3/8" x 1-3/4" Bolt, Course Thread, Grade 8			
12MX1.75X80CS	2	12mm x 80mm Bolt, 1.75, Grade 10.9			
12MFW	4	12mm Flat Washer			
12MNN	2	12mm Nyloc Nut, 1.75 Coarse Thread			

INTRODUCTION BEFORE INSTALLATION...

Installation requires a professional mechanic. In addition to these instructions, professional knowledge of disassembly/reassembly procedures and post installation checks must be known.

PRIOR to beginning, inspect the vehicles steering, driveline, and brake systems, paying close attention to the suspension link arms and bushings, sway bars and bushings, tie rod ends, pitman arm, idler arm, ball joints and wheel bearings. Also check the steering sector-to-frame and all suspension-to-frame attaching points for stress cracks. The overall vehicle must be in excellent working condition; repair or replace all worn parts.

Read instructions several times before starting. Read each step completely as you go.

Be sure you have all needed parts and know where they install.

⚠ NOTES:

- Front end alignment is necessary.
- Tool and Wrench/Socket size is given in brackets [] after each appropriate step.
- A foot-pound torque reading is given in parenthesis () after each appropriate fastener.
- Always wear safety glasses when using power tools.
- Prior to attaching components, be sure all mating surfaces are free of grit, grease, excessive undercoating, etc.
- Do not fabricate any components to gain additional suspension height.
- A factory service manual should be on hand for reference.
- Due to payload options and initial ride height variances, the amount of lift is a 'base figure'. Final ride height dimensions may vary in accordance to original vehicle stance.

BEFORE YOU DRIVE...

Check all fasteners for proper torque. Check to ensure for adequate clearance between all rotating, mobile, fixed, and heated members. Verify clearance between exhaust and brake lines, fuel lines, fuel tank, floor boards and wiring harness. Check steering components for clearance.

Test and inspect brake system. Perform steering sweep to ensure front brake hoses have adequate slack and do not contact any rotating, mobile or heated members. Inspect rear brake hoses at full extension for adequate slack. Failure to perform hose check/replacement may result in component failure.

Perform head light check and adjustment.

⚠ WARNING: It is the ultimate buyer's responsibility to have all bolts/nuts checked for tightness after the first 100 miles and then every 1000 miles. The steering, suspension and driveline systems, plus wheel alignment should be inspected by a qualified professional mechanic at least every 3000 miles.

TIRES & WHEELS...

Larger rim and tire combinations may increase leverage on suspension, steering, and related components. When selecting combinations larger than OE, consider the additional stress you could be inducing on the OE and related components.

⚠ NOTE: Stock 17", 18" and 20" Wheels Will Fit back on the vehicle once this suspension system is installed.

⚠ WARNING: ANY larger or wider tire & wheel combination other than listed Will Require Vehicle Trimming.

IMPORTANT DISCLAIMER: The provided tire/wheel fitments are approximate. Actual dimensions of a given tire size can vary considerably from one brand to another. Manufacturers' wheel offset and backspacing measurement points are not always consistent. Backspacing greatly impacts tire-to-fender clearance when turning. Wheel width and backspacing influence whether the tires protrude past the fenders, and to what extent. Considering these important factors, we recommend that you fit-check your tire/wheel selection prior to purchasing.

TIRE SIZE SPECIFICATIONS			
Tire Size	Wheel	Backspacing (INCH)	Offset (MM)
37 x 12.50 R17	17 x 9	4.00 - 4.75	-24mm -12mm
37 x 12.50 R18	18 x 9	4.00 - 4.75	-24mm -12mm
37 x 12.50 R20	20 x 9	4.00 - 4.75	-24mm -12mm
37 x 12.50 R22	22 x 9	4.00 - 4.75	-24mm -12mm
325/55 R22	22 x 9	4.00 - 4.75	-24mm -12mm
315/50 R24	24 x 9	4.00 - 4.75	-24mm -12mm

TOOLS & TECH...

The chart is a listing of the main tools need to install this lift kit system.

We have also included a **Tech Tip** noted by this icon  **TECH TIP** to help if we have found a quicker or easier way to accomplish a task in the steps.

Tools				
Miscellaneous Tools		Wrench / Socket Sizes		
Floor Jacks	Jack Stands	Standard	Metric	
Adjustable Pliers		1/2"	8mm	19mm
Torque Wrench		9/16"	10mm	21mm
Flathead Screwdriver		5/8"	13mm	22mm
Ball Peen Hammer		3/4"	15mm	24mm
Drill with 3/8" & 1/2" Drill Bits		13/16"	18mm	
Plastic Fastener Removal Tool		7/8"		
Tie Rod Puller Tool		1-1/4"	6mm Allen	

Torque Specifications					
STANDARD			METRIC		
Size	Grade 5	Grade 8	Size	Grade 8.8	Grade 10.9
5/16"	15 ft/lbs.	20 ft/lbs.	6mm	7 ft/lbs.	10 ft/lbs.
3/8"	30 ft/lbs.	35 ft/lbs.	8mm	17 ft/lbs.	24 ft/lbs.
7/16"	45 ft/lbs.	60 ft/lbs.	10mm	33 ft/lbs.	47 ft/lbs.
1/2"	65 ft/lbs.	90 ft/lbs.	12mm	59 ft/lbs.	83 ft/lbs.
9/16"	95 ft/lbs.	130 ft/lbs.	14mm	101 ft/lbs.	131 ft/lbs.
5/8"	135 ft/lbs.	175 ft/lbs.	16mm	146 ft/lbs.	202 ft/lbs.
3/4"	185 ft/lbs.	280 ft/lbs.	18mm	201ft/lbs.	283 ft/lbs.

STEP	PART NUMBER	QTY. PER KIT	DESCRIPTION	NEW ATTACHING HARDWARE	QTY. PER BRACKET	HARDWARE BAG NUMBER
13	55-17-5825	2	Bump Stop Spacer - Front	3/8" x 1-3/4" Bolt, Course Thread, Grade 8	1	77-5834 OR
				3/8" SAE Flat Washer	1	77-5835
				#55-08-5800 - 3/8" Tab Nut	1	77-5834A
13	01-600	1	Coil Springs - Front - Driver Side			
	02-600	1	Coil Springs - Front- Passenger Side			
14	66-10-5825	1	Fixed Lower Link - Front - Driver Side			
	66-11-5825	1	Fixed Lower Link - Front - Passenger Side			
16	55-13-5825	2	Shock Relocation Bracket - Front	#24-5704 - Sleeve, 0.75" OD x 0.50" ID x 1.50" Long	1	77-5834A
				3/8" x 1" Bolt, Course Thread, Grade 8	1	77-5834
				3/8" SAE Flat Washer	1	
				3/8" Flange Nut, Course Thread, Grade 5	1	
				1/2" x 3-1/2" Bolt, Course Thread, Grade 8	1	
				1/2" SAE Flat Washer	2	
				1/2" Nyloc Nut, Course Thread, Grade 5	1	
OR						
17	985-24-177	2	FOX Shocks, Front			
23	55-19-5825	2	Sway Bar End Link - Front	#01-60418 - Poly. Hourglass Bushing, 0.075 x 1.44"	2	77-5834A
				#24-5704 - Sleeve, 0.75" OD x 0.50" ID x 1.50" Long	2	
				12mm x 80mm Bolt, 1.75, Grade 10.9	1	77-5834 OR
				12mm Flat Washer	2	77-5835
				12mm Nyloc Nut, 1.75 Coarse Thread	1	
24	66-23-5825	1	Track Bar - Front - Adjustable			

STEP	PART NUMBER	QTY. PER KIT	DESCRIPTION	NEW ATTACHING HARDWARE	QTY. PER BRACKET	HARDWARE BAG NUMBER
35	66-06-5830	2	Fixed Upper Link - Rear			
36	01-601	1	Coil Springs - Rear - Driver Side			
	02-601	1	Coil Springs - Rear - Passenger Side			
37	55-03-5830	2	Bump Stop Bracket - Rear	5/16" x 1-1/4" Bolt, Coarse Thread, Grade 8	2	77-5836 OR
				5/16" SAE Flat Washer	4	77-5837
				5/16" Nyloc Nut, Course Thread, Grade 5	2	
38	55-04-5830	2	Shock Relocation Bracket - Rear	#55-09-5830 - Sleeve, 0.875" OD x 0.635" ID x 1.563" Lor	1	77-3413B
				1/2" x 1-1/2" Bolt, Coarse Thread, Grade 8	1	77-5836
				1/2" SAE Flat Washer	2	
				1/2" Nyloc Nut, Course Thread, Grade 5	1	
				9/16 x 3-1/2" Bolt, Coarse Thread, Grade 8	1	
				9/16" SAE Flat Washer	2	
			9/16" Nyloc Nut, Course Thread, Grade 5	1		
OR						
39	985-24-220	2	FOX Shocks, Rear			
40	55-01-5830	1	Brake Line Bracket - Rear - Driver Side	5/16" x 1" Bolt, Coarse Thread, Grade 8	1	77-5836
				5/16" SAE Flat Washer	2	
				5/16" Nyloc Nut, Course Thread, Grade 5	1	
40	55-02-5830	1	Brake Line Bracket - Rear - Passenger Side	5/16" x 1" Bolt, Coarse Thread, Grade 8	1	77-5836 OR
				5/16" SAE Flat Washer	2	77-5837
				5/16" Nyloc Nut, Course Thread, Grade 5	1	
41	55-14-3310	2	Sway Bar End Link - Rear	#01-60418 - Poly. Hourglass Bushing, 0.075 x 1.44"	2	77-3413B
				#24-5704 - Sleeve, 0.75" OD x 0.50" ID x 1.50" Long	2	
				12mm x 70mm Bolt, 1.75, Grade 10.9	2	77-5836 OR
				1/2" SAE Flat Washer	1	77-5837
				1/2" USS Flat Washer	2	
				12mm Nyloc Nut, 1.75 Coarse Thread	1	
45	55-05-5830	2	Carrier Bearing Spacer - JT			77-5830
				10mm x 60mm Bolt, 1.5, Grade 8.8	2	77-5836 OR
				10mm Flat Washer	2	77-5837

NOTE: Use the check-off box found at each step to help you keep your place. Two denotes that one check-off box is for the Driver Side (Left) and one is for the Passenger Side (Right). Unless otherwise noted, always start with the Driver Side.

FRONT DISASSEMBLY

NOTE: Save ALL factory components and hardware for reuse, unless noted.

TECH TIP As you uninstall OEM parts, Place the Factory Hardware Back into the Factory Location. This will save you time and make the install easier to complete.

1. PREPARE VEHICLE FOR FRONT...

Disconnect the battery.

Chock rear tires and place transmission in neutral. Raise the front of vehicle with a jack and secure a jack stand beneath each frame rail. Ease the frame down onto the stands, place transmission in Low Gear for Manual Transmission or Park for Automatic. Remove the front wheels & tires. [Lug Nuts 22mm]

2. REMOVE SWAY BAR LINKS...

[Illustration 1] Remove the factory hardware from the lower sway bar link mount at the axle mount. [Bolt: 18mm, Nut: 18mm] Retain factory hardware.

Remove the factory hardware from the upper sway bar link at the sway bar. [6mm Allen | 18mm wrench]

3. REMOVE TRACK BAR...

[Illustration 2] Remove the factory bolt and tab nut from the track bar at the lower axle mount. [21mm]

Remove the factory bolt and nut from the track bar at the frame mount. [21mm]

Remove track bar and retain the factory hardware.

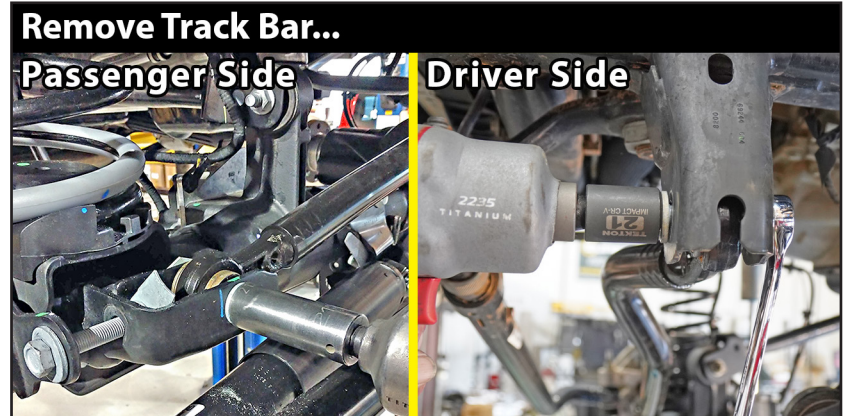
Illustration 1**Illustration 2****4. RUBICONS: DISCONNECT FRONT LOCKER...**

[Illustration 3] **RUBICON Models:** The front locker must be disconnected, so the wiring connectors are not over-extended.

On the Driver Side located on the 'inner' frame rail above the axle, unplug the harness plug. **CAUTION:** This plug is "locked" with plastic clips that must be moved to an "unlocked" position before removal. Unclip the wiring harness clips from the frame. [Plastic Fastener Removal Tool]

5. UNCLIP CENTER AXLE DISCONNECT (CAD)...

[Illustration 4] The Center Axle Disconnect or otherwise known as the CAD, must be disconnected.

On the Passenger Side located on the 'inner' frame rail above the axle, remove the zip tie from the wiring harness. Unclip the wiring harness clips from the frame. [Plastic Fastener Removal Tool]

At the Passenger Side axle, unplug the CAD harness. Unclip wiring clips from front axle. [Plastic Fastener Removal Tool] **NOTE:** Make sure there is adequate slack on all wires.

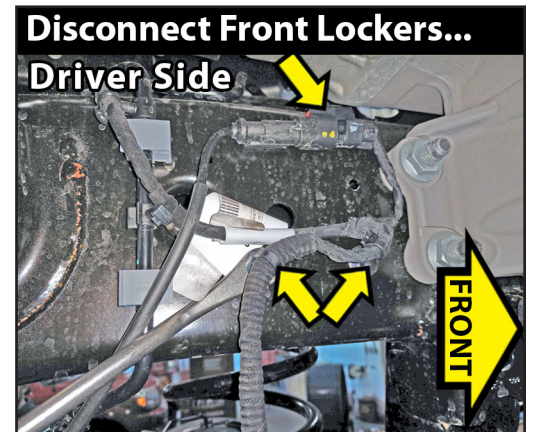
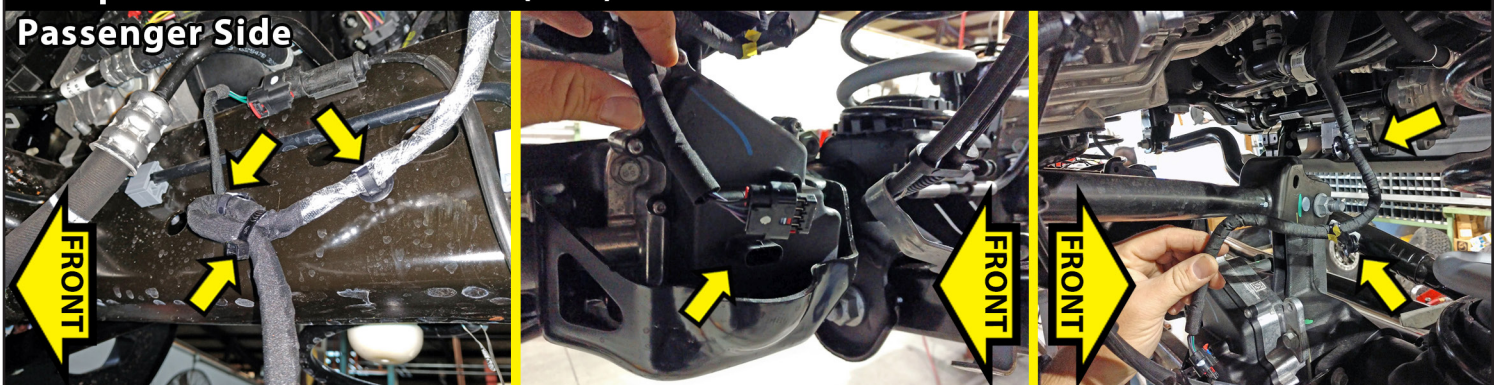
Illustration 3**Illustration 4****Unclip Center Axle Disconnect (CAD)...**

6. REMOVE BRAKE LINE BRACKET...

☐ [Illustration 5] On the Driver Side & Passenger Side, remove the brake line bracket from the lower control arm. [15mm]

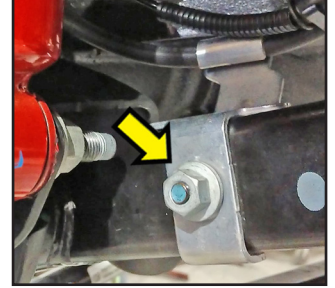
Illustration 5
Remove Brake
Line Bracket...
Driver Side
**7. DISCONNECT FRONT DRIVESHAFT...**

☐ [Illustration 6] Make an alignment mark on the front driveshaft and front differential input yoke.

Remove the four bolts from the yoke. [15mm] Save the driveshaft hardware.

Remove the front driveshaft from the differential. Secure the driveshaft safely up & out of the way with a bungee, mechanic's wire or other method.

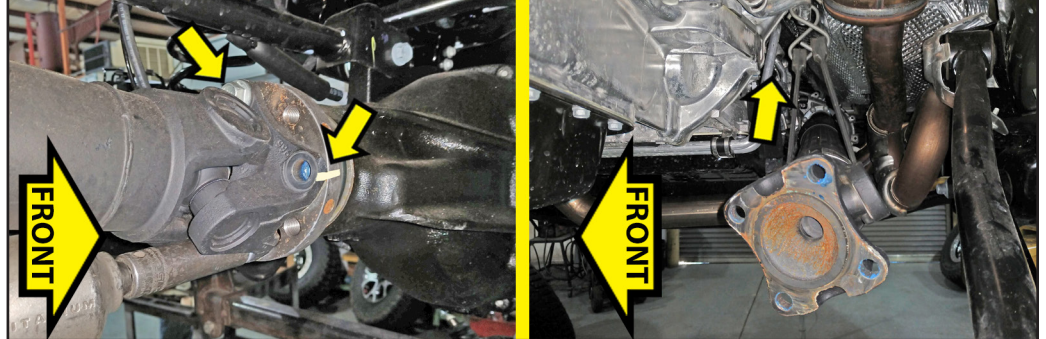
Illustration 6
Disconnect Front Driveshaft...
Driver Side
**8. DISCONNECT FRONT AXLE VENT TUBE...**

☐ [Illustration 7] Locate the brake line bracket attached on the Driver Side frame to the rear of the shock tower. [Plastic Fastener Removal Tool] Unclip the axle vent hose clip from the brake line bracket. Follow the vent tube up and unclip the frame attachment. [Plastic Fastener Removal Tool] Continue to follow the vent tube up and unclip from the shock tower that is behind the wheel well plastic. [Plastic Fastener Removal Tool]

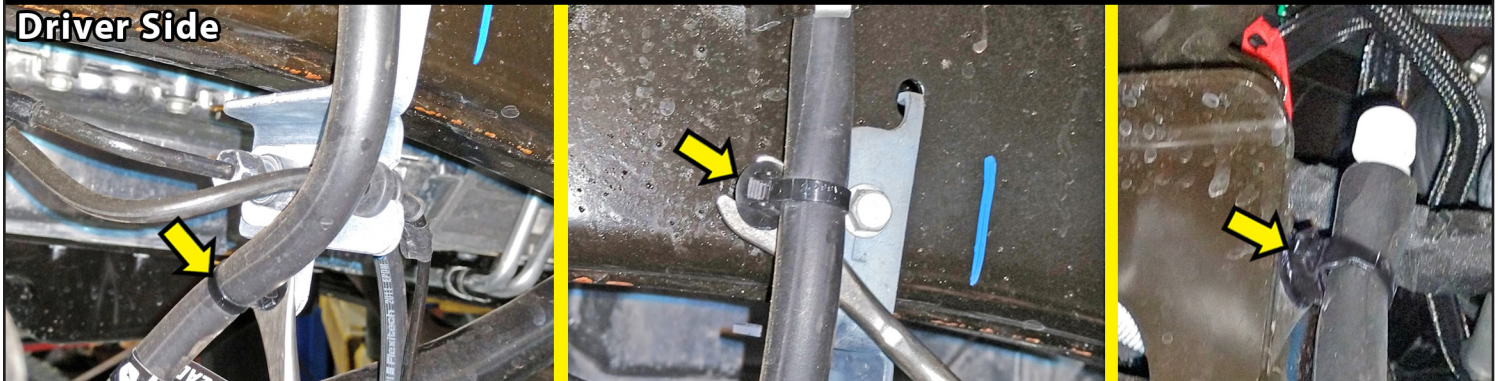
Illustration 7
Disconnect Front Axle Vent Tube...
Driver Side

9. REMOVE FRONT SHOCKS...

⚠ NOTE: If you are installing the Shock Spacer Kit, disconnect the Lower Shock Mount ONLY.

□□ [Illustration 8] Disconnect the shock from the upper shock tower mount. [18mm socket]
Disconnect the shock from the lower mount at the axle. [18mm wrench \ 18mm socket]
Remove shocks. Retain the shocks and shock mount hardware.

Illustration 8**Remove Front Shocks...****Driver Side****10. REMOVE FRONT COIL SPRINGS...**

□□ [Illustration 9] Lower the axle enough to facilitate removing the front coil springs. Remove the coil springs.

REMOVE OEM LOWER CONTROL ARMS...

11. □□ [Illustration 10] Disconnect lower control arms from the front and rear factory mounts. [21mm & 24mm] Remove OEM lower control arms.

DISCONNECT BRAKE LINE...

12. □□ [Illustration 11] Disconnect factory brake line bracket from axle coil spring seat. [10mm] Pull bracket rearward to allow clearance. **⚠ NOTE:** Do not over extend brake lines or ABS lines.

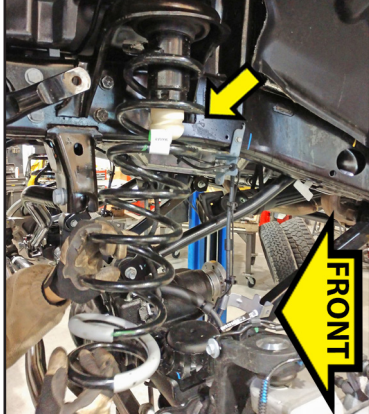
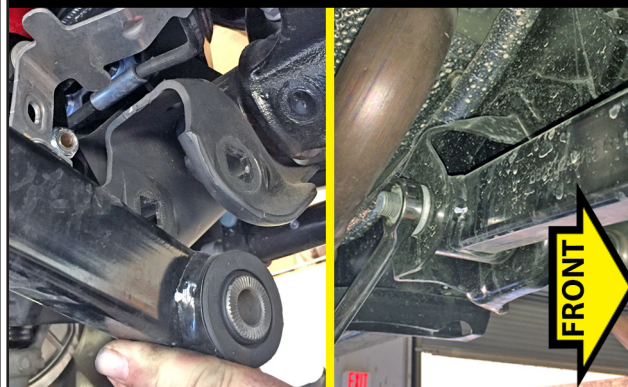
Illustration 9**Remove Front Coils...****Driver Side****Illustration 10****Remove OEM Lower Control Arms...****Illustration 11****Disconnect Brake Bracket...****Driver Side**

FRONT ASSEMBLY

13. INSTALL FRONT BUMP STOP EXTENSIONS & COIL SPRINGS...

Locate the (2) SUPERLIFT #55-17-5825 Bump Stop Spacers - Front.

Locate Hardware Bag #77-5834 **OR** #77-5835. Hardware PER Side: (1) 3/8" x 1-3/4" Bolt, Coarse Thread, (1) 3/8" SAE Washer.

Locate Hardware Bag #77-5834A. Hardware PER Side: (1) #55-08-5800 - 3/8" Tab Nut.

Locate the (2) SUPERLIFT Front Coil Springs. They are side specific. #01-600-Driver Side & #02-600-Passenger Side.

□□ **[Illustration 12-A]** Place a 3/8" SAE Washer onto a 3/8" x 1-3/4" Bolt. Insert the bolt/washer into the top of the bump stop noted by the recessed hole.

□□ **[Illustration 12-B]** Place the bump stop inside of the side specific coil spring. Install the front coil spring with the bump stop inside. Insert the coil spring into the upper tower first. Be sure that the coils are indexed so they seat properly then raise the axle enough to hold the coil springs in place. **TECH TIP** If the front axle cannot be lowered enough to allow the coil spring to be installed, carefully rotate the pinion up to provide more clearance for the coil installation.

□□ **[Illustration 12-C]** The lower coil spring mount pad has a factory hole in the center. Align the bump stop bolt into the hole. Reach under the spring mount pad and above the axle tube to start the #55-08-5800 - 3/8" tab nut onto the bump stop bolt. Tighten bump stop into place. [9/16" socket] (25)

□□ **[Illustration 12-D]** **TECH TIP** On the Passenger Side, it may be necessary to remove the ABS bracket to install the tab nut. At the rear of the axle above the shock mount, remove the ABS mounting bracket. [10mm] Once bump stop spacer is tight, reinstall ABS line mounting bracket onto axle. [10mm]

Illustration 12

Install Front Bump Stop & Coil Springs...

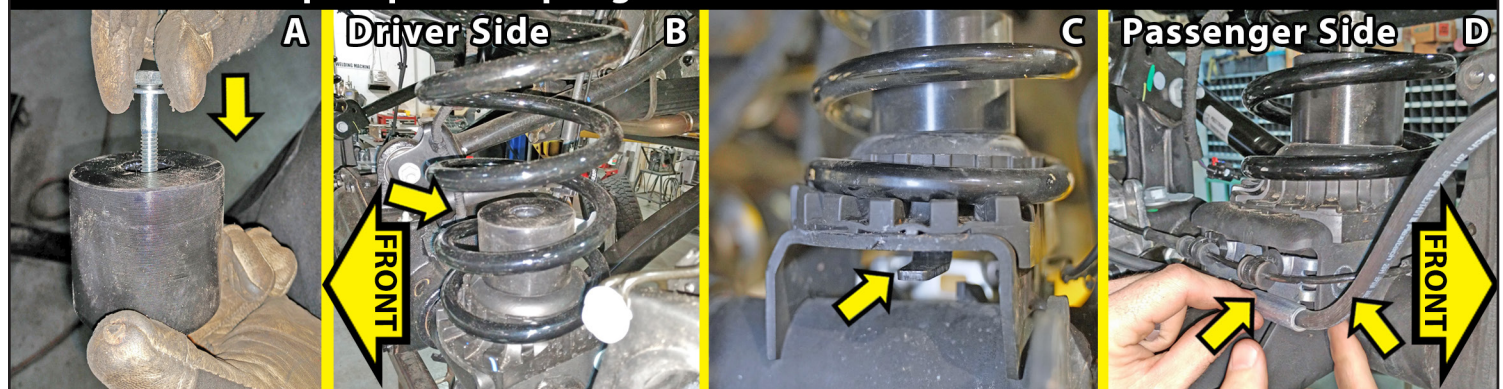

14. INSTALL LOWER CONTROL ARMS...

Locate the (2) SUPERLIFT Fixed Lower Link Arms. These are side specific. #66-10-5825 - Driver Side & #66-11-5825 - Passenger Side.

NOTE: The Part Number is stamped into a welded tab located on the inside of the lower control arm toward the rear mount. The brake bracket mounting stud goes toward the front & points toward the outside of the vehicle.

□□ **[Illustration 13]** Install the new lower control arm into the front & rear

mounts using the factory hardware with the bolt pointing inward. [21mm & 24mm]

Illustration 13

Install Lower Control Arms...

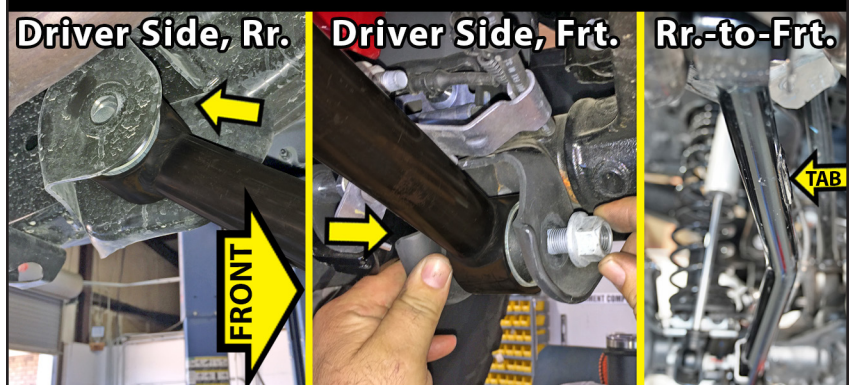

15. RECONNECT BRAKE LINE...

☐☐ [Illustration 14] Reconnect factory brake line bracket from axle coil spring seat. [10mm]

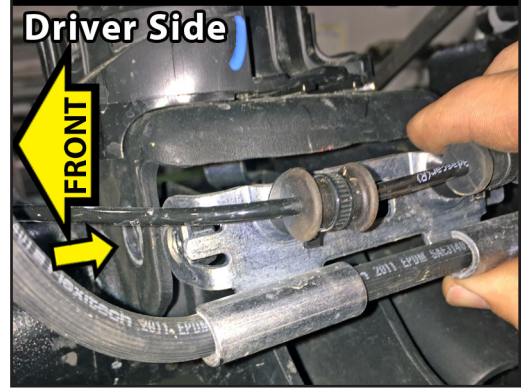
Illustration 14**Reconnect Brake Bracket...****16. INSTALL FRONT SHOCK RELOCATION BRACKET...**

⚠ NOTE: IF you are installing the FOX front shocks, Proceed to Step 17.

Locate the (2) SUPERLIFT #55-13-5825 Shock Relocation Brackets - Front. They are not side specific.

Locate Hardware Bag #77-5834A. Hardware PER Side: (1) #24-5704 Sleeve, 0.75" OD x 0.50" ID x 1.50" Long.

Locate Hardware Bag #77-5834. Hardware PER Side: (1) 3/8" x 1" Bolt, Course Thread, Grade 8, (1) 3/8" SAE Flat Washer, (1) 3/8" Flange Nut, Course Thread, Grade 5 (1) 1/2" x 3-1/2" Bolt, Course Thread, Grade 8, (2) 1/2" SAE Flat Washer & (1) 1/2" Nyloc Nut, Course Thread, Grade 5.

☐☐ [Illustration 15-A] Swing the shock rearward and up out of the way. Place the #55-13-5825 Shock Relocation Bracket on the factory shock mount with pointing rearward and up. Place a 3/8" SAE washer onto the 3/8" x 1" bolt. Insert the bolt/washer up through the bottom hole of the bracket/factory mount. Install 3/8" flange nut. [9/16 wrench / 9/16 socket] **TECH TIP** The bottom hole of the factory shock mount may have to be deburred before the bolt is installed easily. Use a 3/8" drill bit to deburr the hole if needed.

☐☐ [Illustration 15-B] Place a 1/2" SAE Flat Washer onto a 1/2" x 3-1/2" Bolt. Insert the bolt/washer pointing inward into the shock spacer/factory shock mount. Insert #24-5704 sleeve. Continue bolt through spacer/shock mount, then attach 1/2" SAE Flat Washer & 1/2" Nyloc Nut. Snug tighten only. [3/4" wrench | 3/4" socket]

☐☐ [Illustration 15-C] Swing factory shock into place and align with the upper hole of the Relocation Bracket. Install shock with factory hardware with the bolt pointing inward. Snug tighten only. [18mm wrench | 18mm socket]

⚠ NOTE: Shocks will be tightened completely when the vehicle is set on the ground.

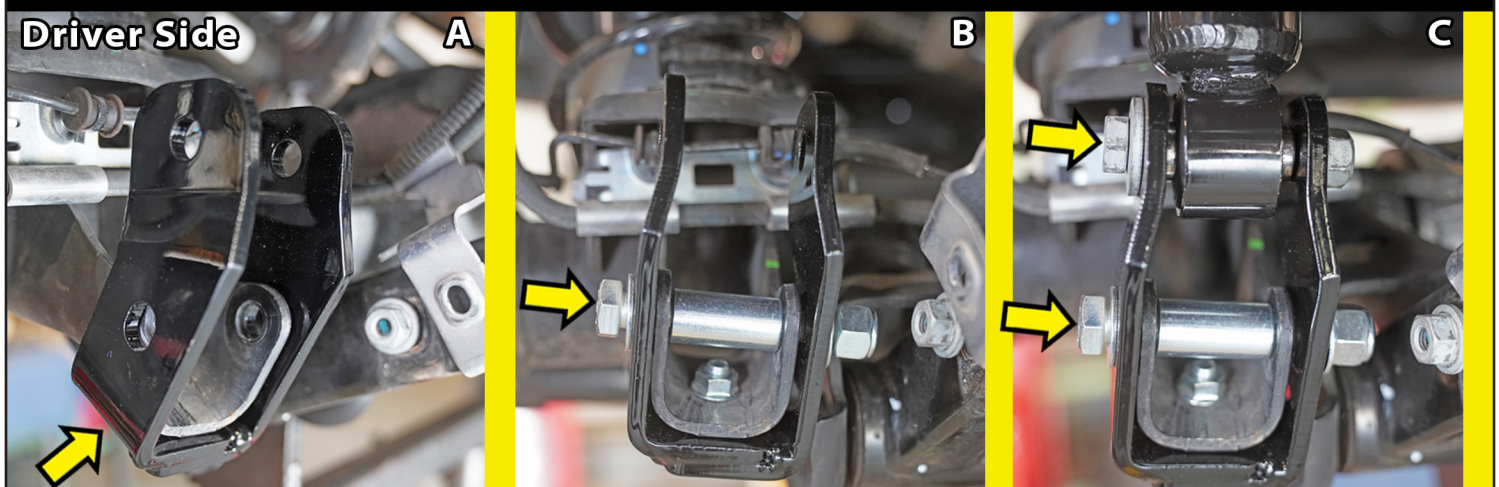
Illustration 15**Install Front Shock Relocation Bracket...**

17. FOX SHOCK INSTALL...

Locate the (2) #985-24-177 FOX Shocks.

☐☐ [Illustration 16] Install the FOX front shocks using the factory hardware at the upper shock tower mount. Tighten the upper hardware until bushings swell slightly. [18mm socket]

⚠ **NOTE:** The upper shock mount has a factory fixed nut in place on the frame. Be careful not to dislodge nor over tighten this nut.

Attach the shock at the lower mount at the axle using the factory hardware. [18mm wrench | 18mm socket]

Snug tighten only. Shocks will be tightened completely when the vehicle is set on the ground.

18. ATTACH BRAKE LINE BRACKET TO LOWER CONTROL ARM...

☐☐ [Illustration 17] On the Driver Side & Passenger Side, attach the brake line bracket to the lower control arm using the factory flange nut. [15mm]

19. REATTACH FRONT AXLE VENT TUBE...

Locate the brake line bracket attached on the Driver Side frame to the rear of the shock tower.

☐ [Illustration 18] Re-clip the axle vent hose clip to the brake line bracket. Follow the vent tube up and re-clip to the frame attachment. Continue to follow the vent tube up and re-clip to hole on the shock tower.

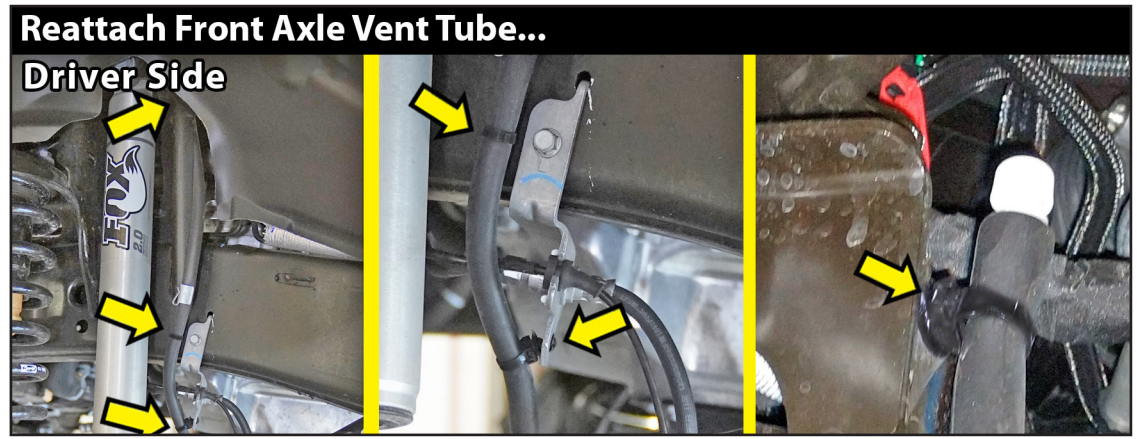
Illustration 17**Illustration 18****20. REATTACH FRONT DRIVESHAFT...**

Locate the front driveshaft factory bolts. Apply thread locking compound to the factory bolt threads before installation.

☐ [Illustration 19] Align mark on the front driveshaft and front differential input yoke, reconnect the front driveshaft to the front differential. [15mm] (81)

🔧 **TECH TIP** With the bolts in place, use a pry bar to keep the driveshaft from turning while you tighten & torque into place.

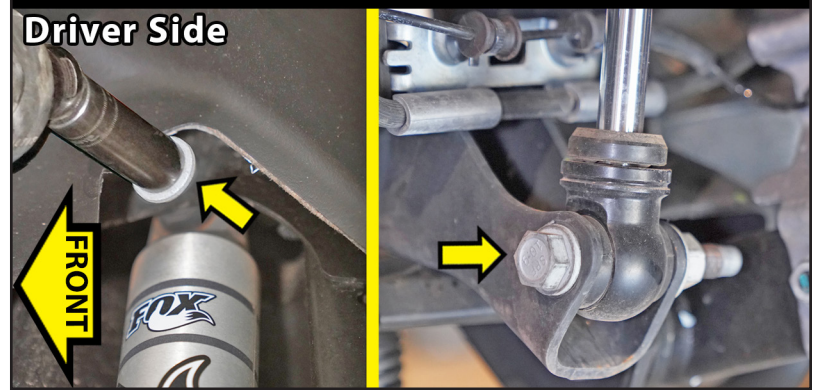
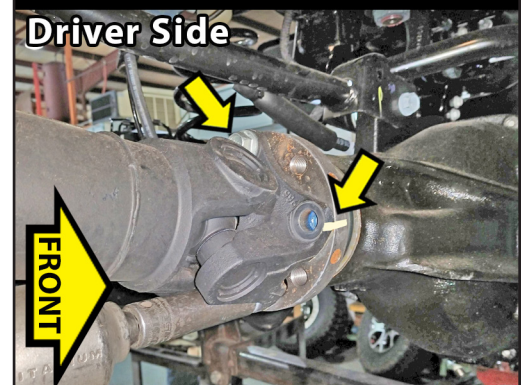
Illustration 16**Install Front FOX Shocks...****Illustration 19****Reattach Front Driveshaft...**

21. RUBICONS: RECONNECT FRONT LOCKER...

RUBICON Models: □ [Illustration 20] On the Driver Side located on the 'inner' frame rail above the axle, reconnect the plug wiring harness together & re-clip back to the frame. Reconnect so the wiring connectors are not over-extended.

22. RECONNECT CENTER AXLE DISCONNECT (CAD)...

□ [Illustration 21] At the Passenger Side axle, reconnect the CAD harness. On the Passenger Side on the 'inner' frame rail above the axle, reconnect the plug wiring harness together & re-clip back to the frame. Reconnect so the wiring connectors are not over-extended.

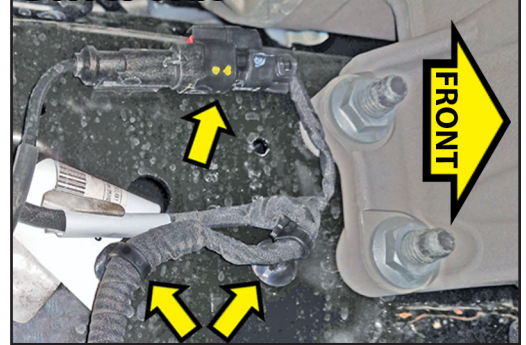
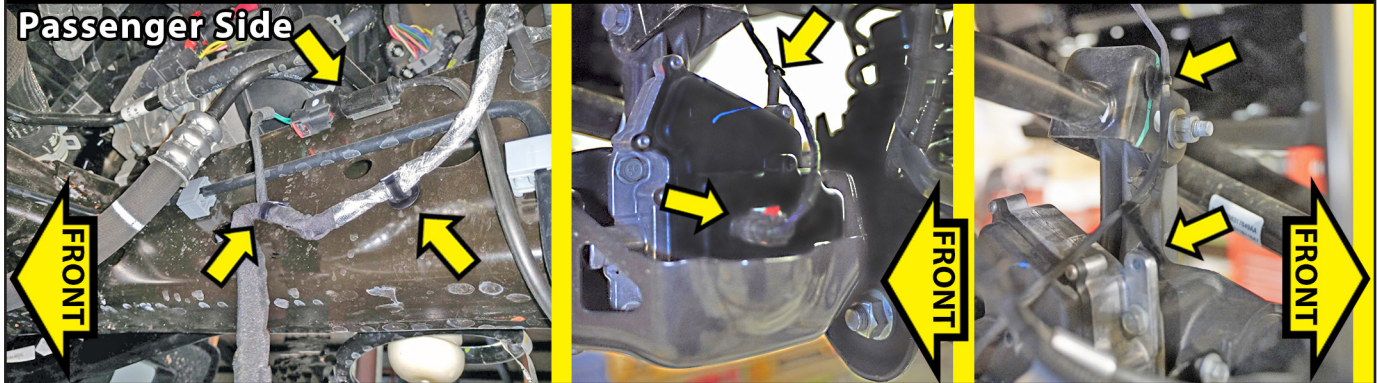
Illustration 20**Illustration 20****Reconnect Front Lockers...****Driver Side****Reconnect Center Axle Disconnect (CAD)...****Passenger Side****23. INSTALL FRONT SWAY BAR END LINKS...**

Locate the (2) SUPERLIFT #55-19-5825 Sway Bar End Links - Front. **⚠ NOTE:** These supplied front sway bar links are shorter than the supplied rear sway bar links.

Locate Hardware Bag #77-5834A. Hardware PER Side: (2) #01-60418 - Poly. Hourglass Bushing, 0.075 x 1.44" & (2) #24-5704 - Sleeve, 0.75" OD x 0.50" ID x 1.50" Long.

Locate Hardware Bag #77-5834 **OR** #77-5835. Hardware PER Side: (1) 12mm x 80mm Bolt, 1.75, Grade 10.9, (2) 12mm Washers & (1) 12mm Nyloc Nut, 1.75 Coarse Thread.

□□ [Illustration 22-A] Lightly grease and install/press the #01-60418 hourglass shaped bushing and #24-5704 - Sleeve into each end of the sway bar link end.

□□ **⚠ NOTE:** [Illustration 22-B] The sway bar links have an offset. [Illustration 22-C] On the upper end link mount, place a 12mm Washer onto a 12mm x 80mm Bolt. Insert the bolt/washer pointing inward into the #55-19-5825 Sway Bar End Link. Continue bolt through outside of the sway bar, then attach with 12mm Washer & 12mm Nyloc Nut. Snug tighten only. [19mm wrench | 19mm socket]

On the lower end link mount, use the factory bolt & tab nut to attach the lower sway bar link to the factory axle mount. On the driver side, use the factory hardware to attach the lower link to the inside of the axle mount. Sway bar lower link mounts will be tightened when the vehicle is on the ground.

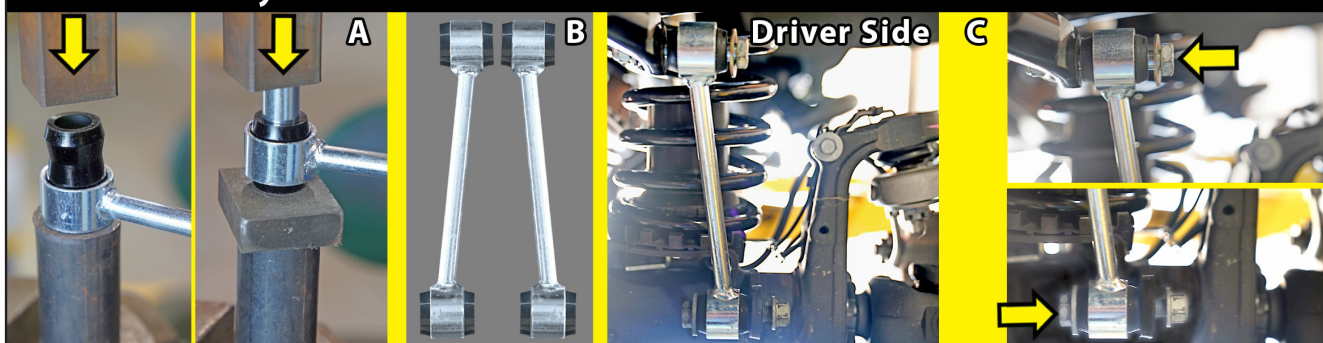
Illustration 22**Install Front Sway Bar End Links...**

24. INSTALL REPLACEMENT ADJUSTABLE FRONT TRACK BAR...

Locate the SUPERLIFT Track Bar - Front - Adjustable (#66-23-5825).

[Illustration 23-A] Position the upper end of the bar in the factory mount at the frame and secure it using the factory bolt & nut. Secure, but do not tighten at this time.

[Illustration 23-B] Insert the adjustable end of the track bar in factory mount at the axle. To adjust the length and to align with the factory mount, loosen the (2) Allen head pinch bolts. [5/16" Allen] Turn the adjuster bolt to adjust end. [1-1/4" | 32mm] **NOTE:** The maximum amount of adjustment is no more than 1-1/8" of exposed threads as measured from the end of the track bar. **TECH TIP** A ratchet strap will help position the track bar. Attach the ratchet strap to the track bar upper frame mount & to the lower axle mount. Ratchet the strap to align the track bar with the mount hole.

Secure using the factory bolt & tab nut. Secure, but do not tighten at this time. Track bar will be torqued when on the ground.

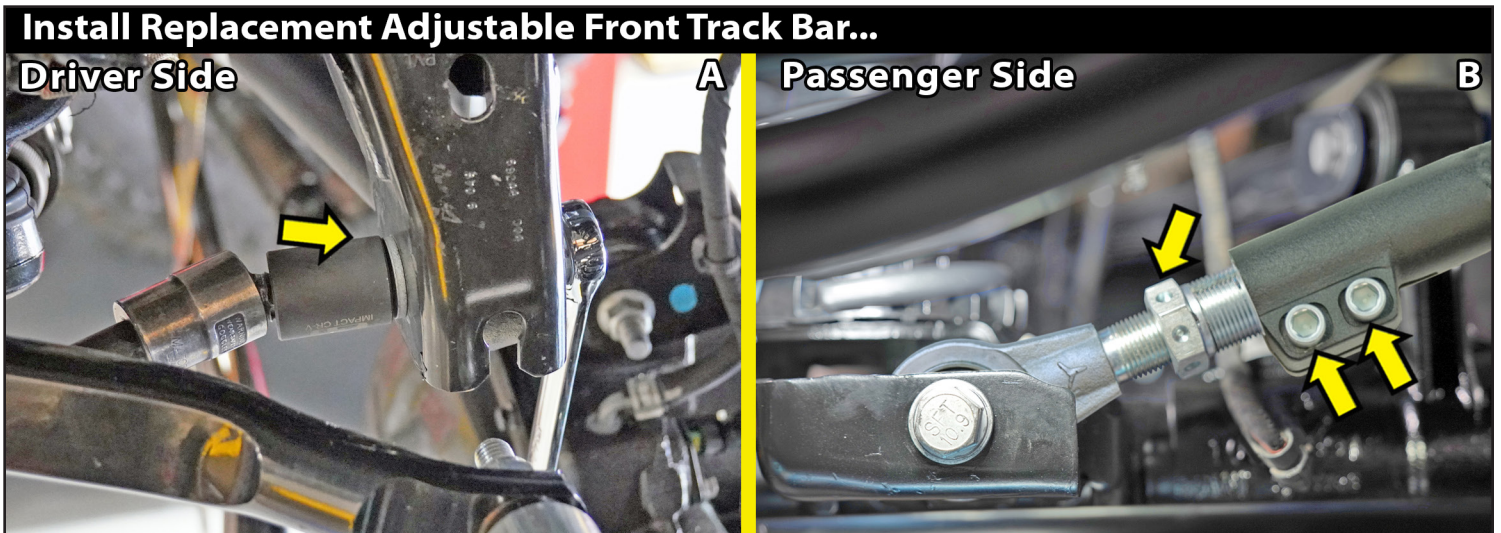
Illustration 23**25. FRONT TIRES / WHEELS...**

[Illustration 24] Install the front tires & wheels. [Lug Nuts 22mm] (140) Lower the vehicle to the ground.

WARNING: When the tires / wheels are installed, always check for and remove any corrosion, dirt, or foreign material on the wheel mounting surface, or anything that contacts the wheel mounting surface (hub, rotor, etc.). Installing wheels without the proper metal-to-metal contact at the wheel mounting surfaces can cause the lug nuts to loosen and the wheel to come off while the vehicle is in motion.

Reconnect the battery.

Illustration 24**Lug Nut Torque Sequence...**

Follow the Sequence Below to Torque the Lug Nuts

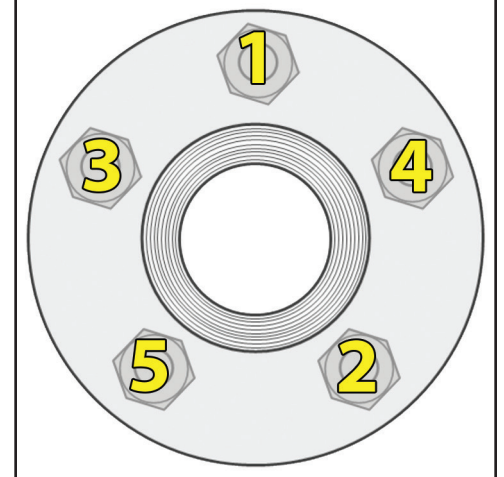

26. FRONT TRACK BAR ADJUSTMENT...

[Illustration 25] Check to make sure the body is centered over the axle. Verify that the tires are pointed straight ahead. Measure from the outside edge of the frame to the inside of the tire on the passenger side. Record this measurement, then repeat the procedure on the driver side.

Compare the two measurements recorded in the previous step; the goal is to make them equal. If the driver side measurement is greater than the passenger side, the track bar needs to be lengthened. If the passenger side measurement is greater than the driver side, the track bar needs to be shortened. In most cases, the track bar on a lifted vehicle needs to be longer than stock. **⚠ NOTE:** The maximum amount of adjustment is no more than 1-1/8" of exposed threads as measured from the end of the track bar.

Wiggle the front tires back and forth several times to fully seat the track bar.

Repeat the measuring procedure to verify the adjustments made were correct. Check to make sure the body is centered over the axle. Adjust track bar end link as needed. [1-1/4" | 32mm]

[Illustration 23-A & 23-B] Tighten & torque Front Track Bar upper and lower mounts. [21mm] (125)

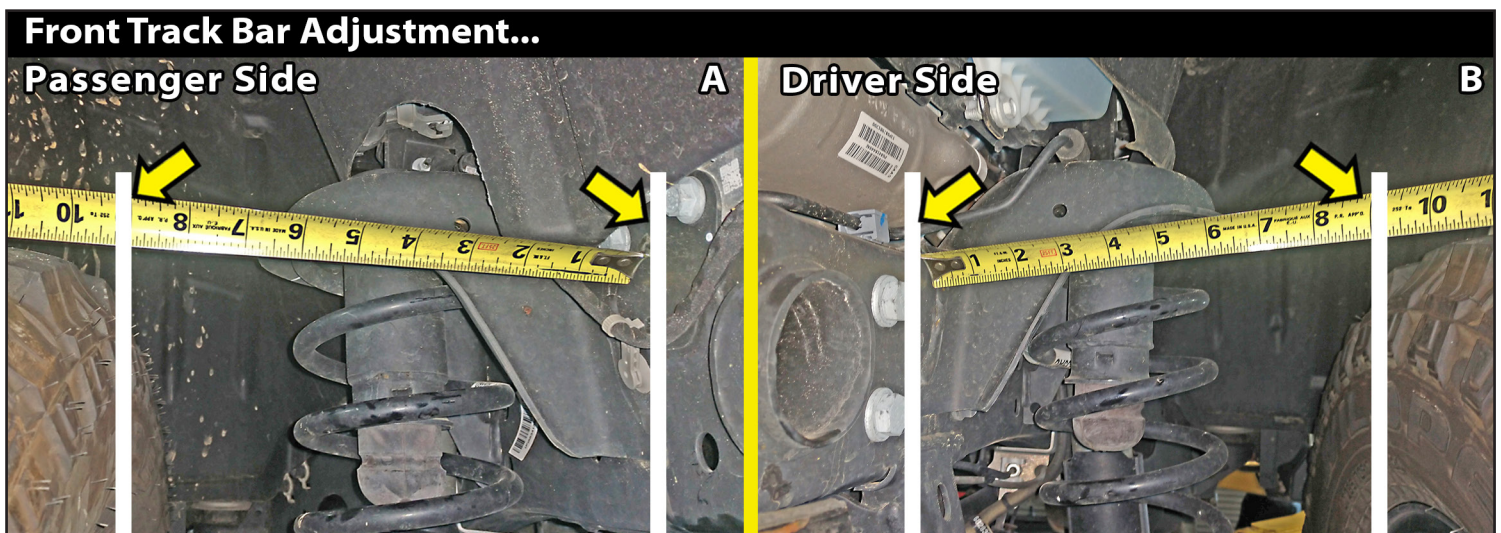
Illustration 25**27. HARDWARE TIGHTENING SEQUENCE...**

[Illustration 15-B] Front Shock Relocation Bracket at lower mount. [18mm wrench | 18mm socket] (55)

[Illustration 15-C] Front Shock Relocation Bracket at shock mount. [3/4" wrench | 3/4" socket] (65)

[Illustration 16] Front FOX shock upper & lower eye mounts. [18mm wrench | 18mm socket] (55)

[Illustration 22] Front Sway Bar Links at frame and at sway bar. [19mm wrench | 19mm socket] (75)

28. INITIAL FRONT CLEARANCE CHECK...

With the vehicle on the ground, cycle the steering lock-to-lock and check all components for proper operation and clearances. Pay special attention to the clearance between the tires / wheels and control arms, brake hoses, ABS wiring, etc.

Raise the vehicle back onto jack stands and secure as per **Step 1**. With the suspension 'hanging' at full extension travel, cycle the steering lock-to-lock and check all components for proper operation and clearances. Pay special attention to the clearance between the tires / wheels and control arms, brake hoses, ABS wiring, driveshaft-to-crossmember, etc.

Lower vehicle to the floor. Final tightening and adjustments to the front suspension installation will take place once rear lift is completed.

REAR INSTALLATION **NOTE:** Save ALL factory components and hardware for reuse, unless noted.

29. PREPARE VEHICLE FOR REAR...

Chock front tires and place transmission in neutral. Raise the rear of vehicle with a jack and secure a jack stand beneath each frame rail. Ease the frame down onto the stands, place transmission in Low Gear for Manual Transmission or Park for Automatic. Remove the rear wheels & tires. [Lug Nuts 22mm Deep Well Socket]

Support the rear axle with a hydraulic jack. Leave plenty of room to lower the rear axle.

30. REMOVE FACTORY BRAKE LINE BRACKET & SWAY BAR LINKS...

[Illustration 25-A] Remove the factory brake line bracket from the outside frame rail (next to sway bar link mount). [10mm]

[Illustration 25-A] Disconnect the upper sway bar link at the outside frame rail. [21mm]

[Illustration 25-B] Disconnect the lower sway bar link at the sway bar. [6mm Allen | an 18mm wrench]

Illustration 25

Remove Factory Brake Line Bracket & Sway Bar Links...

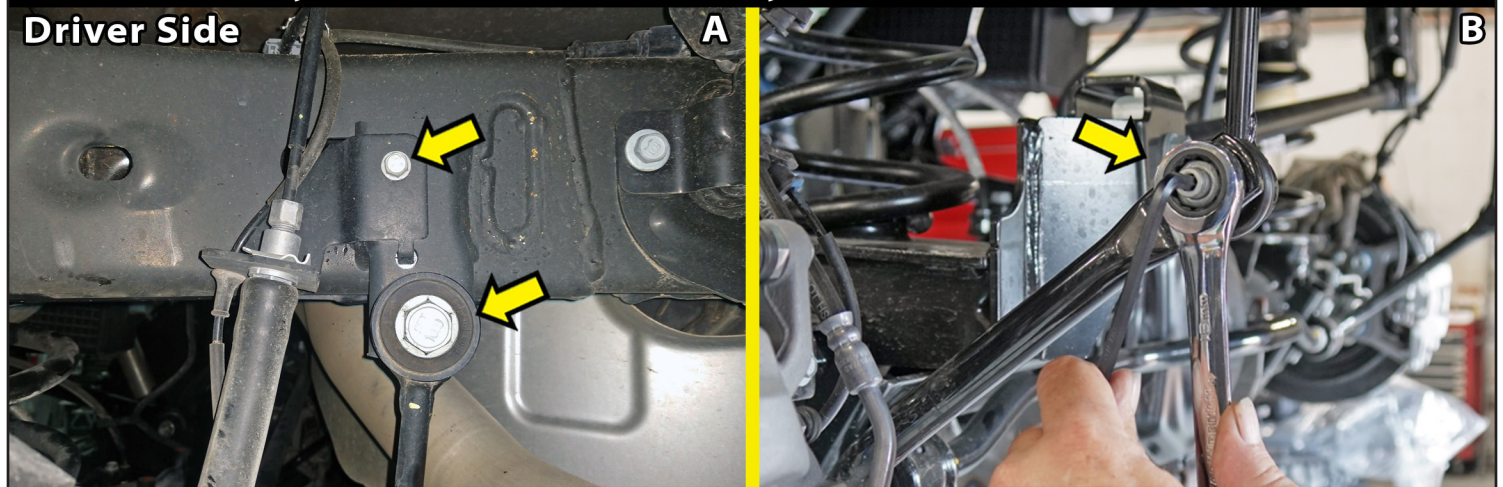

31. RUBICONS: DISCONNECT REAR LOCKER...

[Illustration 26] **RUBICON Models:** The rear locker must be disconnected, so the wiring connectors are not over-extended. On the rear axle, unplug the locker wiring harness from the passenger side of the differential. [Plastic Fastener Removal Tool] **CAUTION:** This plug is "locked" with plastic clips that must be moved to an "unlocked" position before removal.

Illustration 26

RUBICON Models: Disconnect Rear Locker...

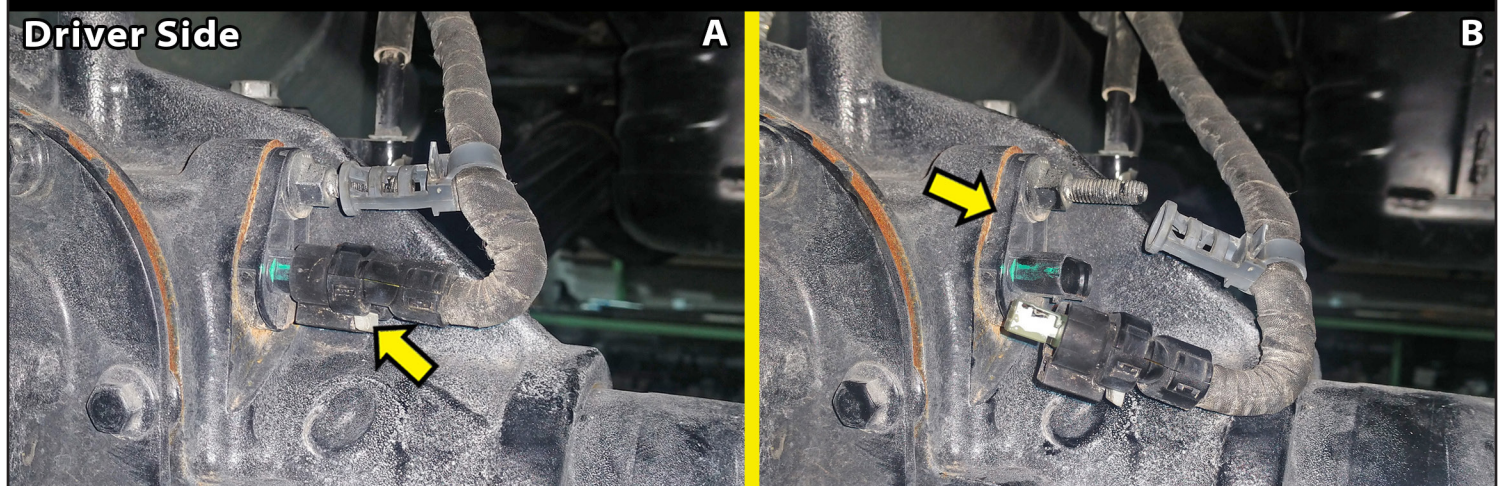

32. DISCONNECT REAR BRAKE CALIPER & BRAKE LINE BRACKET...

[Illustration 27-A] Disconnect the brake line bracket from below the bump stop mount pad at the axle (next to the coil spring mount). [10mm] Retain factory hardware.

[Illustration 27-B] Disconnect the brake caliper by removing two (2) bolts. [10mm] Remove the brake caliper from the rotor. Secure the caliper away from the work area. **⚠ NOTE:** Do not let calipers hang from brake lines.

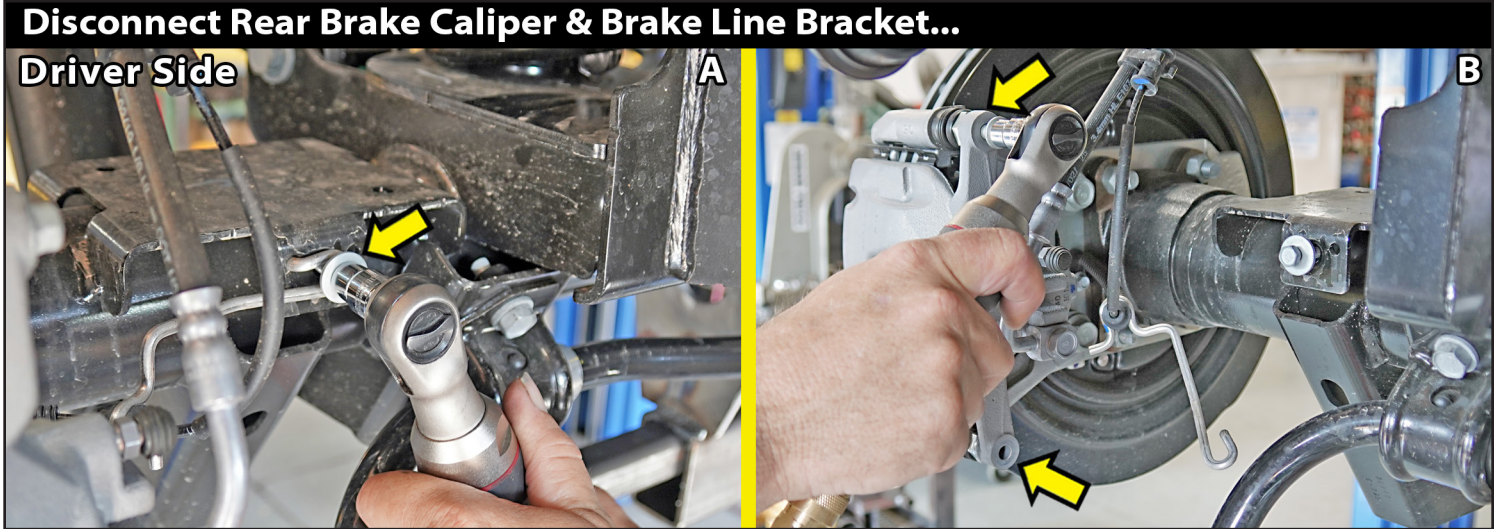
Illustration 27**33. DISCONNECT REAR TRACK BAR AT THE DRIVE SIDE AXLE MOUNT...**

[Illustration 28] Disconnect the rear track bar from the driver side axle mount. [21mm] Retain factory hardware. **🔧 TECH TIP** It may be necessary to raise or lower the axle to take the pressure off of the track bar bolt.

Illustration 28**Disconnect Rear Track Bar...****34. DISCONNECT REAR SHOCKS & REMOVE COIL SPRINGS...**

⚠ NOTE: If you are installing the Shock Spacer Kit, disconnect the Lower Shock Mount ONLY. If replacing shock absorbers with FOX shocks, remove shocks completely.

[Illustration 29-A] Disconnect the lower shock mount. [21mm] Retain factory hardware.

🔧 TECH TIP You can work around the shock during installation or you can remove the shock completely by disconnecting the upper mount.

[Illustration 29-B] Disconnect the upper shock mount. [21mm] Remove shock & retain factory hardware.

[Illustration 29-C] Loosen both the upper and lower link arms at the frame. [21mm | 24mm]

[Illustration 29-D] Lower the axle enough to facilitate removing the rear coil springs. Remove the coil springs. Retain the upper factory coil spring isolator. Discard coil springs.

⚠ NOTE: The factory upper spring isolator are Side Specific to properly align with the frame holes. Place upper coil spring isolator in the upper coil bucket and mark its orientation on the isolator and the upper coil bucket. Mark isolators: Driver & Passenger also.

Illustration 29

Disconnect Rear Shock Absorbers & Remove Rear Coils...



35. INSTALL REPLACEMENT UPPER LINKS/CONTROL ARMS...

Locate the (2) SUPERLIFT Fixed Upper Links - Rear (#66-06-5830). They are not side specific.

☐☐ Remove the factory upper link arm [21mm | 24mm] **⚠ NOTE:** Remove and install one side at a time.

☐☐ [Illustration 30-A & 30-B] Place the SUPERLIFT Fixed Upper Link into the factory mounts and install with the factory hardware. Run the bolts from outside-to-inside. [21mm | 24mm]

Illustration 30

Install Replacement Upper Links/Control Arms...

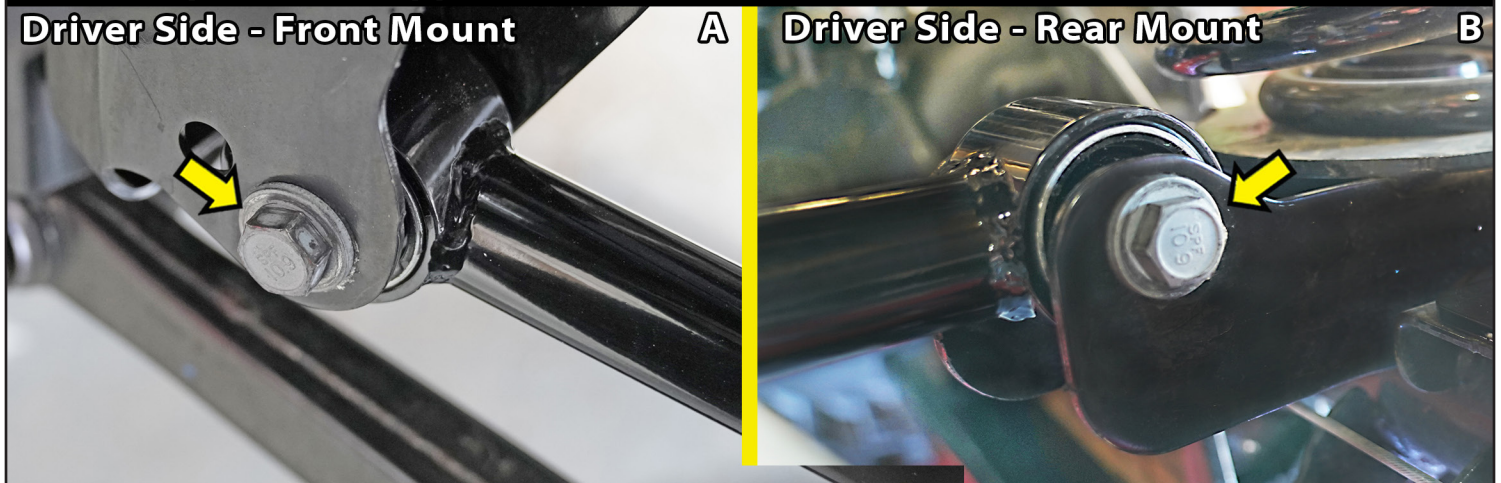

36. INSTALL REPLACEMENT COIL SPRINGS...

Locate the (2) SUPERLIFT Coil Springs - Rear. These are side specific. #01-601 - Driver Side & # 02-601 - Passenger Side.

- Lower the axle enough to facilitate installing the new, taller rear coil springs.
- Place the factory spring isolator of the side specific coil spring (#01-601 - Driver Side & # 02-601 - Passenger Side). **⚠ NOTE:** The factory upper spring isolator are Side Specific.
- Insert the coil spring/isolator up into the upper factory mount. Be sure that the coil/isolator is indexed so they seat properly. Raise the axle enough to hold the coil springs in place.
- Rotate the coils so that they seat properly in the coil buckets then raise the axle enough to seat the springs.

37. INSTALL REAR BUMP STOP BRACKETS...

Locate the (2) SUPERLIFT Bump Stop Bracket - Rear (#55-03-5830). They are not side specific.

Locate Hardware Bag #77-5836 **OR** #77-5837. Hardware PER Side: (2) 5/16" x 1-1/4" Bolt, Coarse Thread, Grade 8, (4) 5/16" SAE Flat Washer & (2) 5/16" Nyloc Nut, Course Thread, Grade 5.

- [Illustration 31]** Place the SUPERLIFT rear bump stop bracket onto the bump stop mount pad at the axle next to the coil spring mount. Align the (2) holes in the bracket with the (2) factory holes in the pad. Place a 5/16" SAE Flat Washer onto a 5/16" x 1-1/4" Bolt. Insert the bolt/washer down through the bracket and the factory mount. Reach under the bump stop pad and above the axle tube to secure with 5/16" SAE Flat Washer & 5/16" Nyloc Nut. [1/2"] Tighten & torque. [20]

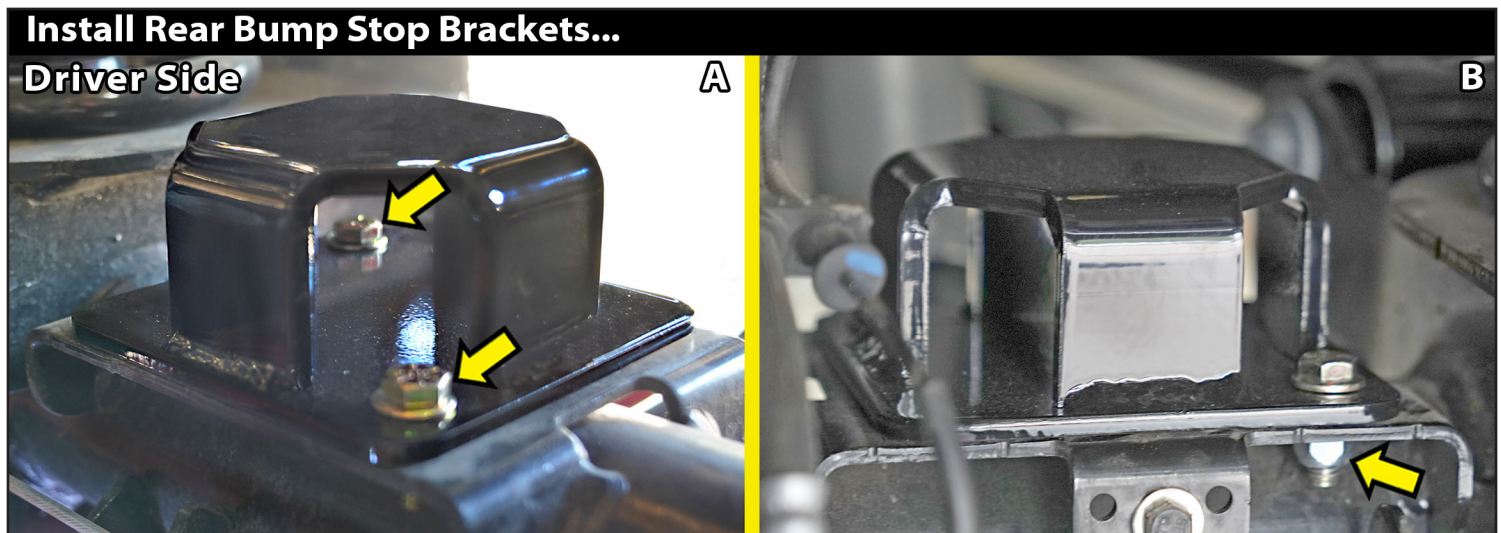
Illustration 31**38. INSTALL REAR SHOCK RELOCATION BRACKET...**

⚠ NOTE: IF you are installing the FOX rear shocks, Proceed to Step 39.

Locate the (2) SUPERLIFT Shock Relocation Bracket - Rear (#55-04-5830). They are not side specific.

Locate Hardware Bag #77-3413B. Hardware PER Side: (1) #24-5704 - Sleeve, 0.75" OD x 0.50" ID x 1.50" Long

Locate Hardware Bag #77-5836 **OR** #77-5837. Hardware PER Side: (1) 1/2" x 1-1/2" Bolt, Coarse Thread, Grade 8, (2) 1/2" SAE Flat Washers, (1) 1/2" Nyloc Nut, Course Thread, Grade 5 (1) 9/16 x 3-1/2" Bolt, Coarse Thread, Grade 8, (2) 9/16" SAE Flat Washers & (1) 9/16" Nyloc Nut, Course Thread, Grade 5.

- [Illustration 32-A]** Slide the #55-04-5830 Shock Relocation Bracket over the outside of the factory lower shock mount and rotate to align the lower holes.
- [Illustration 32-B]** Place a 9/16" SAE Flat Washer onto a 9/16" x 3-1/2" Bolt. Insert the 9/16" bolt/washer through the factory bracket. Place the #24-5704 Sleeve inside the bracket and insert the bolt through the bracket and frame mount. Attach with 9/16" Nyloc Nut. Secure, but do not tighten. [13/16" bolt | 7/8" nut]
- 🔧 TECH TIP** If you tighten the lower bolt too much, you will not be able to get the shock inside of the relocation bracket.

☐☐ **[Illustration 32-C]** Swing factory shock into place and align with the upper hole of the bracket. Install shock with factory hardware with the bolt pointing inward. Snug tighten only. [21mm] Shocks will be tightened completely when the vehicle is set on the ground.

☐☐ **[Illustration 32-D]** On the back of the shock bracket, make sure the bracket is pushed up and properly aligned with the factory mount. Using the bracket as a guide, drill a 1/2" hole.

☐☐ **[Illustration 32-E & 32-F]** Place a 1/2" SAE Flat Washer onto a 1/2" x 1-1/2" Bolt. Insert the 1/2" bolt/washer through the bracket and the newly drilled hole going rear-to-front. Attach with 1/2" SAE Flat Washer & 1/2" Nyloc Nut. Tighten & torque [3/4"] (90)

Illustration 32

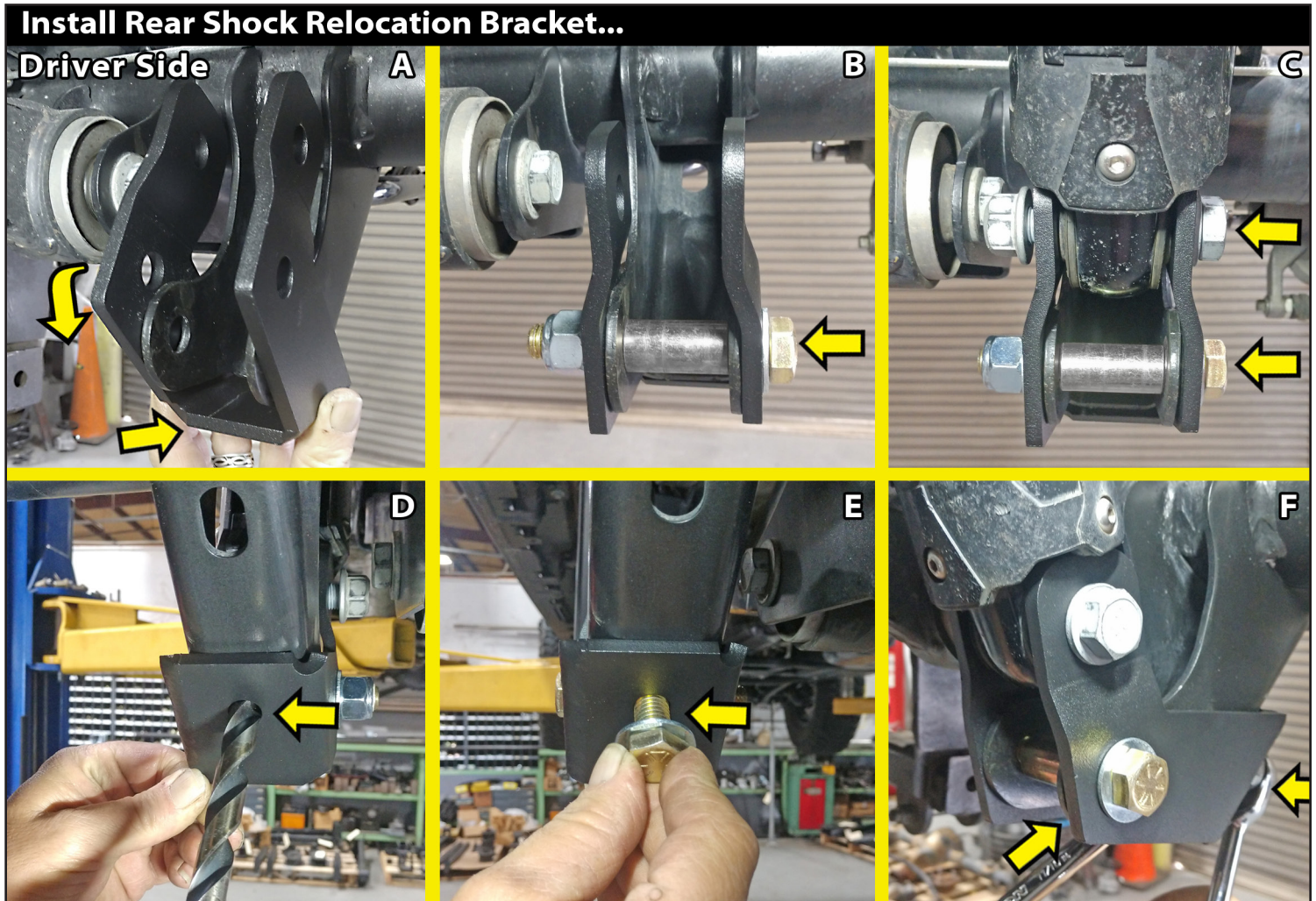

39. INSTALL REPLACEMENT FOX SHOCK ...

Locate the (2) FOX Shocks - Rear (#985-24-220).

☐☐ Attach the #985-24-220 FOX shock at the upper frame mount using the factory hardware with the bolt pointing inward. Snug tighten only. [21mm] Shocks will be tightened completely when the vehicle is set on the ground.

☐☐ Attach the FOX shock at the lower mount at the axle using the factory hardware with the bolt pointing inward. Snug tighten only. [21mm]

40. REATTACH REAR BRAKE CALIPER & BRAKE LINE BRACKET...

☐☐ [Illustration 33-A] Reattach the brake caliper with two (2) factory bolts. [10mm]

☐☐ [Illustration 33-B] Reattach the factory brake line bracket to the bump stop mount pad with factory hardware. [10mm]

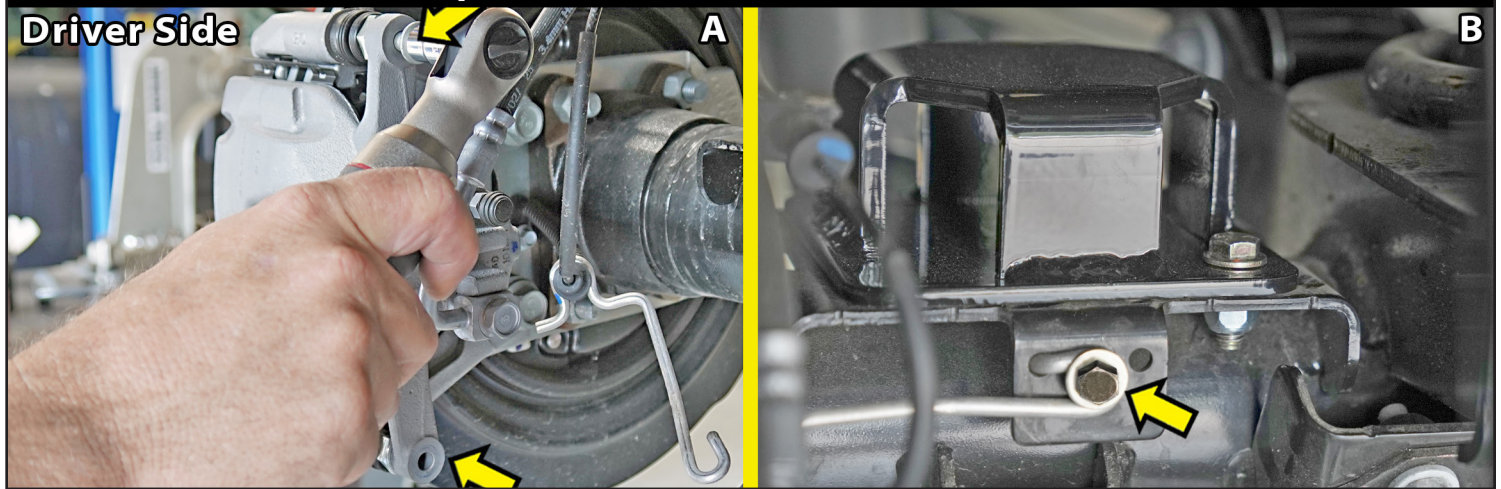
Illustration 33**Reattach Rear Brake Caliper & Brake Line Bracket...****41. INSTALL REAR SWAY BAR END LINK...**

Locate the (2) SUPERLIFT Sway Bar End Link - Rear (#55-14-3310). These are side specific.

Locate Hardware Bag #77-3413B **OR** #77-5836A. Hardware PER Side: (2) #01-60418 - Poly. Hourglass Bushing, 0.075 x 1.44" & (2) #24-5704 - Sleeve, 0.75" OD x 0.50" ID x 1.50" Long.

Locate Hardware Bag #77-5836 **OR** #77-5837. Hardware PER Side: (2) 12mm x 70mm Bolt, 1.75, Grade 10.9, (1) 1/2" SAE Flat Washer, (2) 1/2" USS Flat Washer & (1) 12mm Nyloc Nut, 1.75 Coarse Thread.

☐☐ [Illustration 22-A] Lightly grease and install/press the #01-60418 hourglass shaped bushing and #24-5704 - Sleeve into each end of the sway bar link end. (Same process as installed in the front sway bar links.)

☐☐ [Illustration 34-A] **⚠ NOTE:** The sway bar link is straight so there is not a specific top or bottom. On the upper end link mount, place a 1/2" USS Flat Washer (wider washer) onto a 12mm x 70mm Bolt. Insert the bolt/washer through the #55-14-3310 Sway Bar End Link and attach to the factory mount on the frame rail. Snug tighten only. [19mm] The sway bar links will be tightened completely with the vehicle on the ground.

☐☐ [Illustration 34-B] On the lower end link mount, place a 1/2" SAE Flat Washer onto a 12mm x 70mm Bolt. Insert the bolt/washer through the sway bar then through the #55-14-3310 Sway Bar End Link. Secure with 1/2" USS Flat Washer & 12mm Nyloc Nut. Snug tighten only. [19mm]

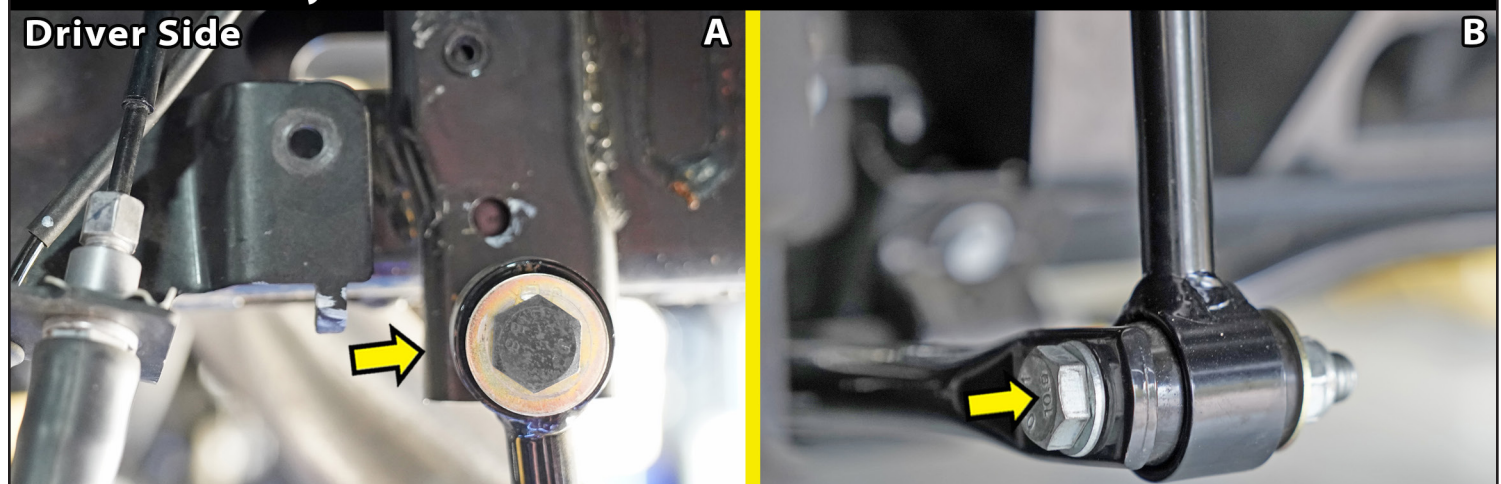
Illustration 34**Install Rear Sway Bar End Link...**

42. INSTALL REAR BRAKE LINE BRACKET...

Locate the (2) SUPERLIFT Brake Line Brackets - Rear. These are side specific. #55-01-5830 - Driver Side & # 55-02-5830 - Passenger Side

Locate Hardware Bag #77-5836 **OR** #77-5837. Hardware PER Side: (1) 5/16" x 1" Bolt, Coarse Thread, Grade 8, (2) 5/16" SAE Flat Washer & (1) 5/16" Nyloc Nut, Course Thread, Grade 5.

[Illustration 35-A] Attach the factory brake line bracket to the SUPERLIFT Brake Line Bracket (#55-01-5830 - Driver Side & # 55-02-5830 - Passenger Side). Place a 5/16" SAE Flat Washer onto a 5/16" x 1" Bolt. Align the lower tab of the factory bracket with the lower hole of the Brake Line Bracket. Insert the 5/16" bolt/washer through the factory bracket and new bracket. Attach with 5/16" SAE Flat Washer & 5/16" Nyloc Nut. [1/2"]

[Illustration 35-B] Attach bracket assembly to the factory mount using the factory flange bolt.

CAUTION: It may be necessary to bend the factory metal brake line to attach the SUPERLIFT Brake Line Bracket. If needed, Carefully bend the brake lines to attach the SUPERLIFT bracket to the factory mounting position. Do not kink or over-bend the lines. [10mm] Tighten bracket assembly.

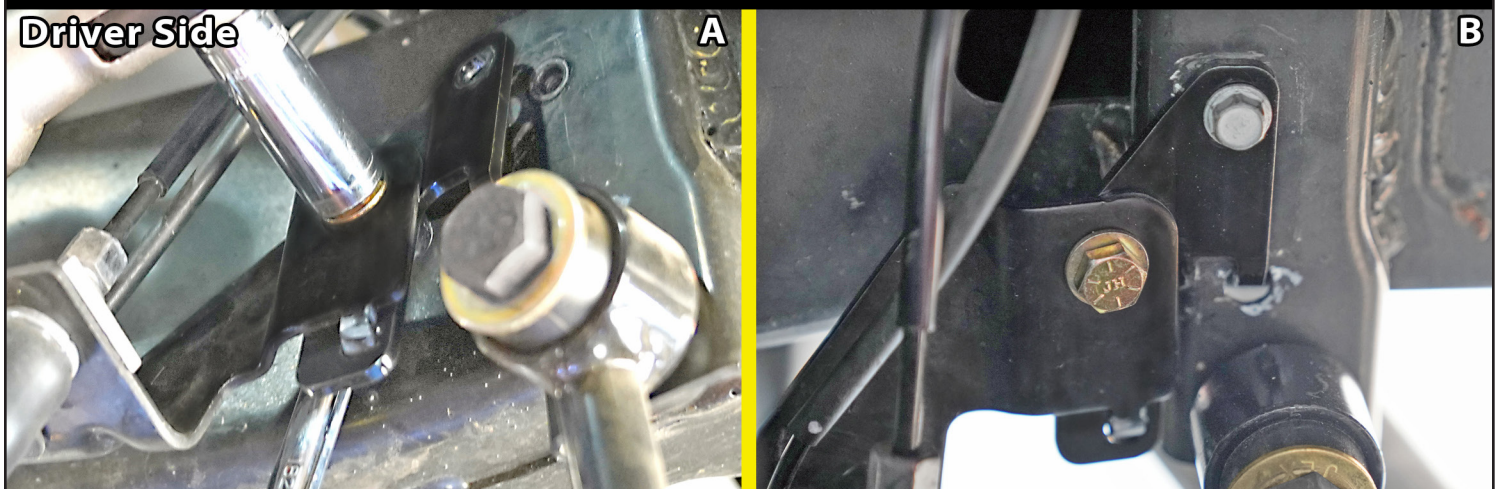
Illustration 35**Install Rear Brake Line Bracket...****43. RUBICONS: RECONNECT REAR LOCKER...**

[Illustration 36] RUBICON Models: Reconnect the locker wiring harness back into the differential.

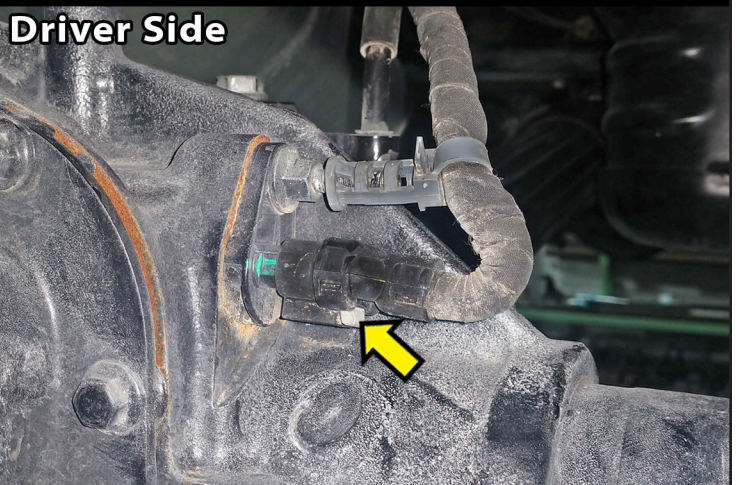
Illustration 36**RUBICON Models: Reconnect Locker...**

44. RECONNECT REAR TRACK BAR...

□ [Illustration 37] Reconnect the track bar to the driver side lower axle mount. Attach using the factory bolt & tab nut. Insert the bolt from rear-to-front. Snug tighten only. [21mm] **NOTE:** Tighten & torque the track bar bolt after the weight of the vehicle is on the suspension. **TECH TIP** It may be necessary to raise or lower the axle to help align the track bar/bolt. A ratchet strap can also help position the track bar. Attach the ratchet strap to the track bar upper frame mount & to the lower axle mount. Ratchet the strap to align the track bar with the mount hole.

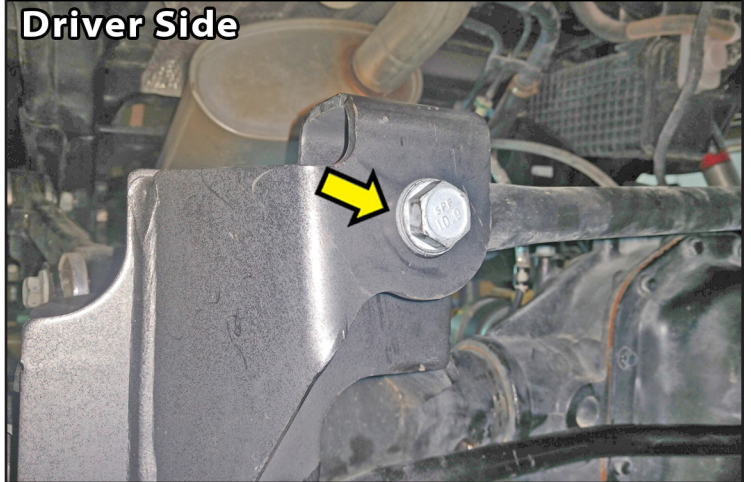
Illustration 37**Reconnect Rear Track Bar...****Driver Side****45. INSTALL CARRIER BEARING SPACERS - JT...**

Locate Hardware Bag #77-5830. Hardware PER Side: (2) #55-05-5830 Carrier Bearing Spacers - JT. These are not side specific.

Locate Hardware Bag #77-5836 **OR** #77-5837. Hardware PER Side: (2) 10mm x 60mm Bolt, 1.5, Grade 8.8 & (2) 10mm Flat Washer.

□ Support the rear driveshaft with a jack or jack stand. Remove the (2) carrier bearing bolts. [16]

□ [Illustration 38] Place a 10mm Flat Washer onto a 10mm x 60mm Bolt. Insert the bolt/washer up through the carrier bearing mount. Place the #55-05-5830 Carrier Bearing Spacer in between the bracket and insert the bolt/washer into the crossmember. [17mm] Tighten & torque. (33)

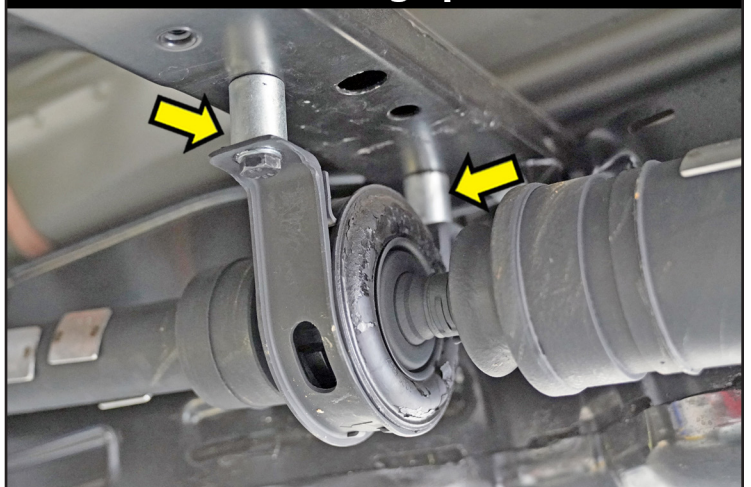
Illustration 38**Install Carrier Bearing Spacers - JT...****46. REAR TIRES / WHEELS...**

□□ [Illustration 24] Install the front tires & wheels. [Lug Nuts 22mm] (140) Lower the vehicle to the ground.

WARNING: When the tires / wheels are installed, always check for and remove any corrosion, dirt, or foreign material on the wheel mounting surface, or anything that contacts the wheel mounting surface (hub, rotor, etc.). Installing wheels without the proper metal-to-metal contact at the wheel mounting surfaces can cause the lug nuts to loosen and the wheel to come off while the vehicle is in motion.

WARNING: Re-tighten lug nuts at 500 miles after any wheel change, or anytime the lug nuts are loosened. Failure to do so could cause wheels to come off while vehicle is in motion.

Illustration 24**Lug Nut Torque Sequence...**

Follow the Sequence Below to Torque the Lug Nuts

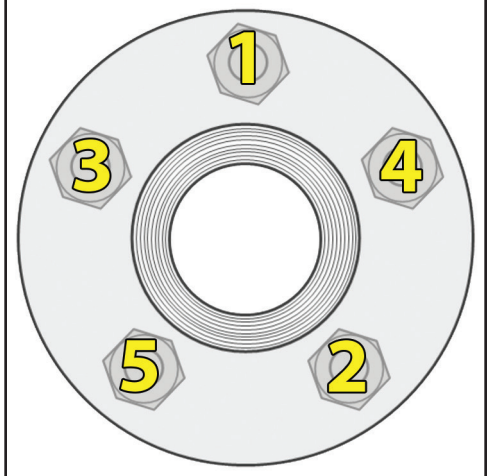

FINAL CHECKS

47. CLEARANCE CHECK...

- Check all hardware for proper torque specifications.

With the vehicle on the ground, check all components for proper operation and clearances. Pay special attention to the clearance between the tires / wheels, brake hoses, wiring, etc.

- Lower the vehicle to the ground.

48. HARDWARE TIGHTENING SEQUENCE...

- [Illustration 23] Front track bar bracket & track bar at axle end. (125)
- [Illustration 22] Front shock relocation bracket at lower mount. (55)
- [Illustration 22] Front shock relocation bracket at shock mount. (55)
- [Illustration 16] Front FOX shock absorber upper & lower mounts. (55)
- [Illustration 22-B] Front sway bar links at axle & at sway bar. (75)
- [Illustration 37] Rear track bar at axle end. (125)
- [Illustration 32-B] Rear shock relocation bracket at lower mount. (55)
- [Illustration 32-C] Rear shock relocation bracket at shock mount. (55)
- Rear FOX shock absorber upper & lower mounts. (55)
- [Illustration 34-A & 34-B] Rear sway bar links at frame and at sway bar. (75)

49. WHEEL ALIGNMENT...

- Realign vehicle to factory OEM specifications. It is necessary to have a proper and professional wheel alignment performed by a certified alignment technician. Align the vehicle to factory specifications. It is recommended that your vehicle alignment be checked after any off-road driving.

50. HEADLIGHTS...

- Re-adjust headlights to proper setting. In addition to your vehicle alignment, for your safety and others, it is necessary to check and adjust your vehicle head lamps for proper aim and alignment.

51. FOUR WHEEL DRIVE...

- Activate the four wheel drive system and check for proper engagement.

52. SUPERLIFT WARNING DECAL...

- ⚠️WARNING:** Install the WARNING TO DRIVER decal on the inside of the windshield, or on the dash, within Driver's view.

IMPORTANT MAINTENANCE INFORMATION

⚠️WARNING: It is the ultimate buyer's responsibility to have all bolts / nuts checked for tightness after the first 100 miles and then every 1000 miles. The steering, suspension and driveline systems, plus wheel alignment should be inspected by a qualified professional mechanic at least every 3000 miles.

LIMITED LIFETIME WARRANTY / WARNINGS

Your SUPERLIFT® product is covered by the Limited Warranty explained below that gives you specific legal rights. This limited warranty is the only warranty SUPERLIFT® makes in connection with your product purchase. SUPERLIFT® neither assumes nor authorizes any retailer or other person or entity to assume for it any other obligation or liability in connection with this product or limited warranty.

SUPERLIFT, LLC, LIMITED LIFETIME WARRANTY

What is covered? Subject to the terms below, SUPERLIFT® will repair or replace its products found defective in materials or workmanship for so long as the original purchaser owns the vehicle on which the product was originally installed. Your warranter is SUPERLIFT, LLC, doing business as SUPERLIFT® Suspension Systems ("SUPERLIFT®").

What is not covered? Your SUPERLIFT® Limited Warranty does not cover products SUPERLIFT® determines to have been damaged by or subjected to:

- Alteration, modification or failure to maintain.
- Normal wear and tear (bushings, rod ends, etc.). Scratches or defects in product finishes (powder coating, plating, etc.).
- Damage to, or resulting from, the vehicle's electronic stability system, related components or other vehicle systems.
- Racing or other vehicle competitions or contests. Accidents, impact by rocks, trees, obstacles or other aspects of the environment.
- Theft, vandalism or other intentional damage.

If a replacement part is needed before the SUPERLIFT® part in question can be returned, you must first purchase the replacement part. Then, if the part in question is deemed warrant-able, you will be credited / refunded.

OTHER LIMITATIONS - EXCLUSION OF DAMAGES - YOUR RIGHTS UNDER STATE LAW

- Neither SUPERLIFT® nor your independent SUPERLIFT® dealer are responsible for any time loss, rental costs, or for any incidental, consequential or other damages you may have.
- This Limited Warranty gives you specific rights, and this is the only warranty SUPERLIFT® makes in connection with your product purchase. You may also have other rights that vary from state to state. For example, while all implied warranties are disclaimed herein, any implied warranty required by law is limited to the terms of our Limited Lifetime Warranty as described above. Some states do not allow limitations of how long an implied warranty lasts and / or do not allow the exclusion or limitation of incidental or consequential damages, so the limitations and exclusions herein may not apply to you. SUPERLIFT® neither assumes nor authorizes any retailer or other person or entity to assume for it any other obligation or liability in connection with this product or Limited Warranty.

IMPORTANT PRODUCT USE AND SAFETY INFORMATION / WARNINGS

⚠ WARNING: As a general rule, the taller a vehicle is, the easier it will roll over. Offset, as much as possible, what is lost in rollover resistance by increasing tire track width. In other words, go "wide" as you go "tall"; always use as wide a tire and wheel combination as feasible to enhance vehicle stability. We strongly recommend, because of rollover possibility, that the vehicle be equipped with a functional roll bar and cage system. Seat belts and shoulder harnesses should be worn at all times. Avoid situations where a side rollover may occur.

Generally, braking performance and capabilities are decreased when significantly larger / heavier tires and wheels are used. Take this into consideration while driving. Also, changing axle gear ratios or using tires that are taller or shorter than factory height will cause an erroneous speedometer reading. On vehicles equipped with an electronic speedometer, the speed signal impacts other important functions as well. Speedometer recalibration for both mechanical and electronic types is highly recommended.

Do not add, alter, or fabricate any factory or aftermarket parts to increase vehicle height over the intended height of the SUPERLIFT® product purchased. Mixing component brands is not recommended.

WE WANT TO SEE YOUR RIDE...

Grab photos of your SUPERLIFT Equipped truck in various poses and in action.



THANKS For Choosing SUPERLIFT...

For questions, technical support and warranty issues relating to this SUPERLIFT products, please contact SUPERLIFT directly.