

Using a 16mm Socket with extension remove the two body mount nuts and the bumper bracket bolt. **NOTE: Bolt may not be present if aftermarket bumper is on vehicle.**

Using a 15mm wrench assemble steel bracket to Linkage assembly. Torque bolts to 20 ft-lbs.

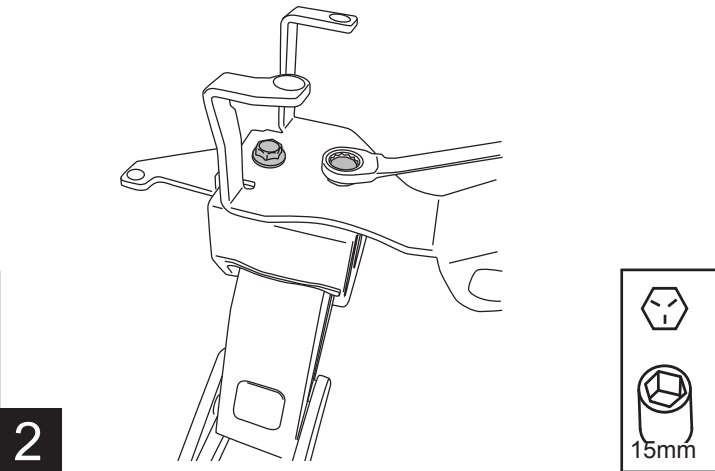
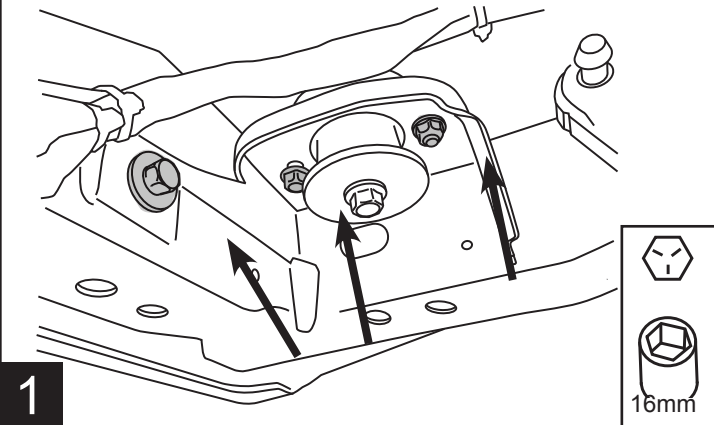

Drop threaded plate into slot in frame. Slot is located on both sides of the frame. The outer slot is preferred but may not be accessible with aftermarket bumpers or racks.

Set assembly into position and replace hardware from step 1. A M10 bolt and washers are supplied if bolt is not present. Do not tighten.

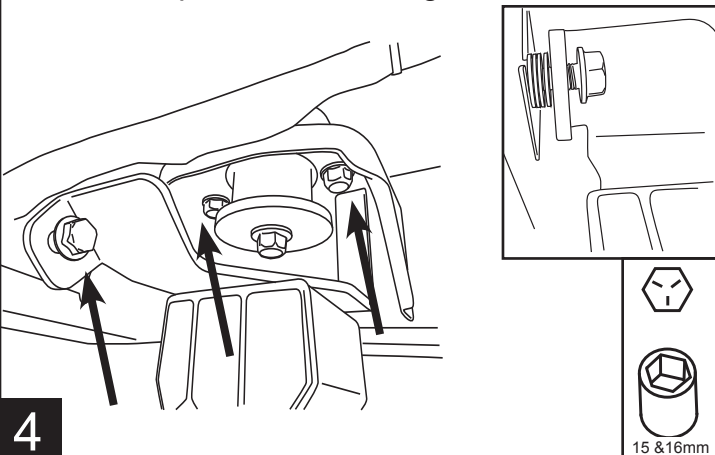
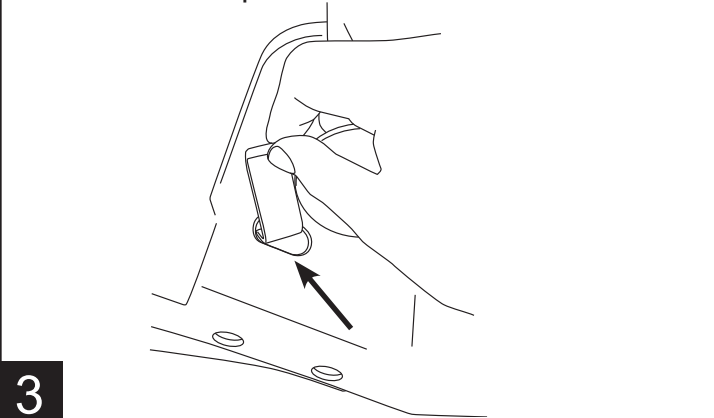

AMP RESEARCH TECH SUPPORT 1-888-983-2204 (Press 2) Monday - Friday, 7:00 AM - 5:00 PM PST

Designed and manufactured by AMP Research®. Patent Number 6,830,257; 6,641,158; 6,834,875; 6,938,909; 6,942,233; 7,007,961; 7,055,839; 7,163,221; 7,367,574; 7,380,807; 7,398,985; 7,413,204; 7,487,986. Other US and Worldwide patents pending. Made in USA © 2009 AMP Research
Three-year limited warranty. Professional installation is recommended.

Thread M8 bolt into threaded bracket from step 3. Torque to 16ft-lbs.

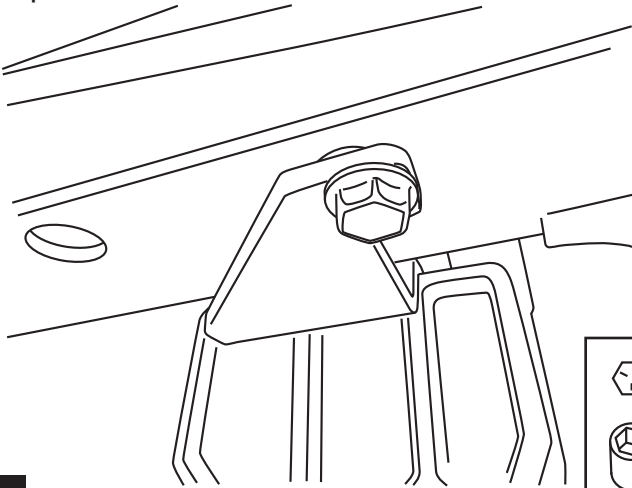

5

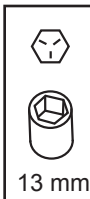

Torque bolt and two factory nuts from step 4 to 20 ft-lbs.

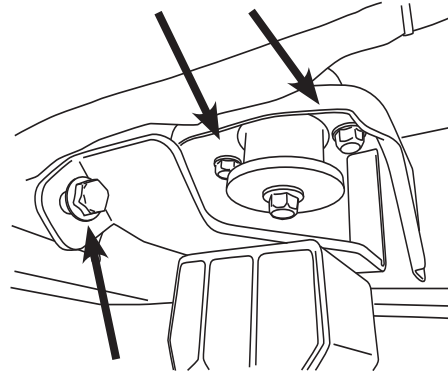

6

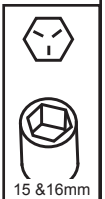

Offset the step pad towards the left and secure using provided PT Screws. Tighten to 5 ft-lbs using T25 torx bit.

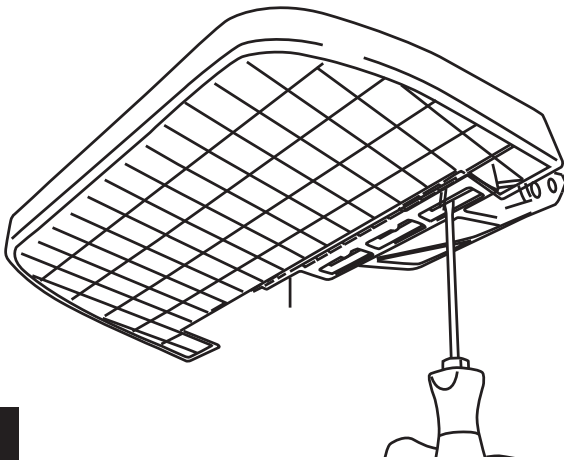

7

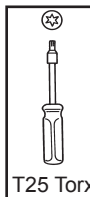

To deploy the step, press down using your foot on the outside edge of the step pad. To retract, gently kick up on the underside of the step pad.

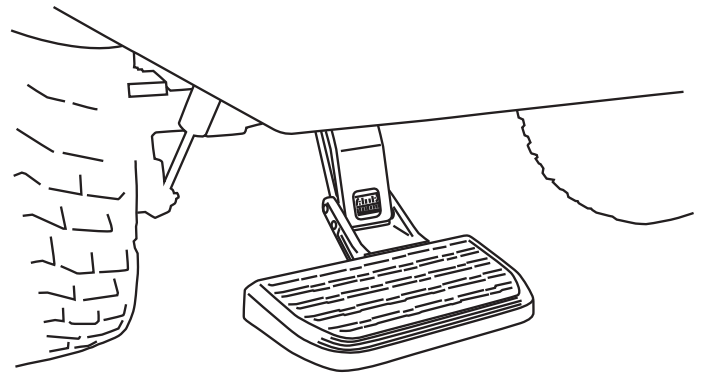

8

Congratulations on the purchase of your AMP RESEARCH BedStep®



Here's what you should know...

OPERATION

- The AMP Research BedStep® is foot operated and deploys and retracts with a nudge of your foot.
- To deploy, press down using your left foot, on the forward outside corner of the step pad.
- To retract, gently kick the underside of the step pad.
- Max Load Capacity: 300lbs.

- Always use appropriate hand holds when stepping up to or down from your truck's cargo bed.

MAINTENANCE TIPS

The step pad surface and linkage arms can be washed with mild soap and water using a soft brush or sponge to dislodge any mud, dirt or accumulated road grime. Rinse with fresh water.

To prevent slipping, avoid applying waxes, lubricants or protectants like Armor All® to the step surface.

ATTENTION!

BEDSTEP SHOULD ALWAYS BE STOWED IN THE RETRACTED POSITION WHEN DRIVING.

LIMITED WARRANTY

AMP RESEARCH warrants product to be free from defects in material and workmanship, for terms specified below, provided there has been normal use and proper maintenance. All remedies under this warranty are limited to the repair or replacement of any item found by the factory to be defective within the time period specified.

If you have a warranty claim, first you must call our factory at the number below for instructions. You must retain proof of purchase and submit a copy with any items returned for warranty work. Upon completion of warranty work, if any, we will return the repaired or replaced item or items to you freight prepaid. Damage to our products caused by accidents, fire, vandalism, negligence, misinstallation, misuse, Acts of God, or by defective parts not manufactured by us, is not covered under this warranty.

THE WARRANTY TIME PERIOD IS AS FOLLOWS: THREE YEARS FROM DATE OF PURCHASE.

ANY IMPLIED WARRANTIES OF MERCHANTABILITY AND/OR FITNESS FOR A PARTICULAR PURPOSE CREATED HEREBY ARE LIMITED IN DURATION TO THE SAME DURATION AND SCOPE AS THE EXPRESS WRITTEN WARRANTY. OUR COMPANY SHALL NOT BE LIABLE FOR ANY INCIDENTAL OR CONSEQUENTIAL DAMAGE.

Some states do not allow limitations on how long an implied warranty lasts, or the exclusion or limitation of incidental or consequential damages, so the above limitations or exclusions may not apply to you. This warranty gives you specific legal rights, and you may also have other rights that vary from state to state.

FOR WARRANTY ISSUES WITH THIS PRODUCT PLEASE CALL AMP RESEARCH CUSTOMER SERVICE 1-888-983-2204

WARNING

Be sure to read and precisely follow the provided instructions when installing this product. Failure to do so could place the vehicle occupants in a potentially dangerous situation. After installing or reinstalling, re-check to insure that the product is properly installed.