



**INSTALLATION MANUAL**  
**MATRIX FRONT BUMPER**  
**PRODUCT NUMBER: X455X**  
**APPLICATION: 2018+ FORD F150**



## **IMPORTANT SAFETY GUIDE** | Your safety and the safety of others is very important.

In order to help you make informed decisions about safety, we have provided the following warnings, safety precautions, installation instructions, and other important information to alert you to potential hazards that could hurt you or others.

Please do a job safety analysis before each task to identify potential hazards for your situation and remove/protect against them. Use own good judgment and take your time.

Check packaged materials immediately upon arrival to ensure that all listed parts are included and undamaged.

**Read and understand all warnings, safety precautions, and instructions before installing this product.**

**SENSORS FIELD OF VIEW MAY BE ALTERED WITH USE OF THE REPLACEMENT BUMPER.**

---

### **WARNINGS**

- Failure to observe the following warnings and instructions provided in this manual could lead to severe injury and/or death.
- For professional installation only. Careless installation and/or operation can result in serious injury, death, and/or equipment damage. All liability for installation and use rests with the user or consumer.
- Fab Fours, Inc. only approves installing this product according to these written instructions with the hardware provided. Failure to install according to these instructions will invalidate the warranty. This includes, but is not limited to, using alternative installation methods, hardware, or materials.
- This product is for off road use only.

---

### **SAFETY PRECAUTIONS**

- Always remove jewelry and wear eye protection.
- Always use extreme caution when jacking up a vehicle for work. Set emergency brake and use tire blocks. Locate and use the vehicle manufacturers designated lifting points. Use jack stands.
- Always use appropriate and adequate care in lifting components into place.
- Always ensure components will remain secure during installation and operation.
- Always wear safety glasses when installing this kit. A drilling operation will cause flying metal chips. Flying chips can cause serious eye injury.
- Always use extreme caution when drilling a vehicle. Always disconnect power before welding. Thoroughly inspect the area to be drilled (on both sides of material when possible) prior to drilling, and relocate any objects that may be damaged.
- Always use extreme caution when welding a vehicle. Thoroughly inspect the area to be welded (on both sides of material when possible) prior to welding, and relocate any objects that may be a fire hazard. When welding in a cab, make sure the interior surfaces are covered (e.g., welding blanket) and a fire extinguisher is at hand.
- Always use extreme caution when cutting and trimming during fitting.
- Always tighten all nuts and bolts securely per installation instructions.
- Always route electrical cables carefully. Avoid moving parts, components that become hot, and rough or sharp edges.
- Always insulate and protect all exposed wiring and electrical terminals.
- Perform regular inspections and maintenance on mounts and hardware.

# TABLE OF CONTENTS

- 2 SAFETY / DISCLAIMER
- 3 TABLE OF CONTENTS
- 4 A MESSAGE FROM THE OWNER
- 5 GETTING STARTED
- 6 PROVIDED MATERIAL
- 7 DISASSEMBLY
- 15 INSTALLATION
- 23 CONTACT

# A MESSAGE FROM THE OWNER

---



Fab Fours' was born out of a passion for customizing vehicles and a love of the outdoors. Our engineering team uses the latest 3D design software to turn new product ideas into reality. In our factory, designs come to life with the combination of cutting edge technology for metal cutting and forming and an American workforce that puts its' heart and pride into every product.

From design and manufacturing, to quality and delivery, Fab Fours' mission is to be the market leader for steel truck and jeep accessories. We make sure a quality product is delivered on time, more than expected, better than expected to our customers.

Enjoy your new Fab Fours product. Welcome to the family!

*Ereg Higgs*

**FOUNDER, FAB FOURS**

# GETTING STARTED

---

Before you begin the installation process of your new Fab Fours product, we suggest laying out all materials and parts on a pad or protective surface.

Failure to fully account for all components before beginning installation may leave vehicle immobile until part is acquired. Refer to the next pages as an inventory check.



# PROVIDED MATERIALS

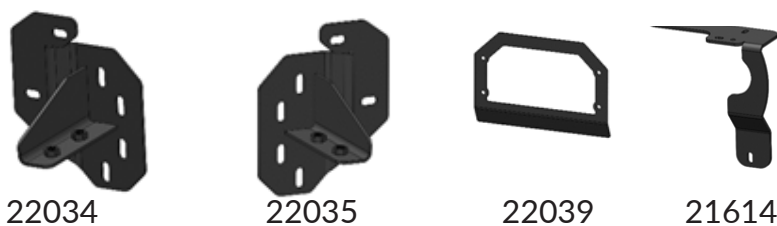
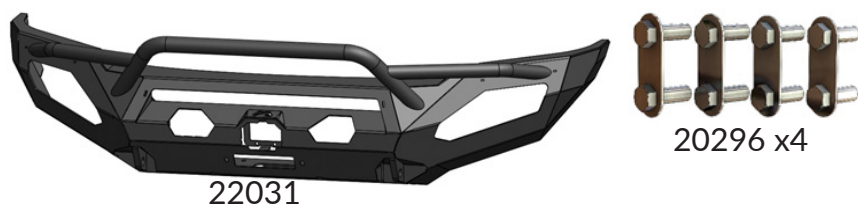

## HARDWARE KIT | 50206

FAB FOURS IDENTIFICATION	COMPONENT DESCRIPTION	QTY
50206-HW	½"-13 x 1.25", Yellow Zinc Hex Bolt, Grade 8	8
50206-HW	½"-13, Yellow Zinc Hex Nut, Grade 8	12
50206-HW	1/2", Yellow Zinc Flat Washer, Grade 8	20
50206-HW	1/2", Yellow Zinc Lock Washer, Grade 8	16
50206-HW	5/16"-18 x 1.25", Yellow Zinc Hex Cap Bolt, Grade 8	8
50206-HW	5/16", Stainless Steel, Fender Washer	4
50206-HW	5/16", Yellow Zinc Lock Washer, Grade 8	4
50206-HW	¼"-20 x 1", Yellow Zinc Hex Cap Bolt, Grade 8	8
50206-HW	1/4", Yellow Zinc Flat Washer, Grade 8	16
50206-HW	1/4", Yellow Zinc Lock Washer, Grade 8	8
50206-HW	1/4", Yellow Zinc Hex Nut, Grade 8	8
50206-HW	#8-32 X ¾", Stainless Steel, Button Head Bolt	4
50206-HW	#8, Stainless Steel, Flat Washer	4
50206-HW	#8-32 Nylock Hex Nut	4

## TOOLS REQUIRED

- 3/4" Socket wrench
- 1/2" Socket wrench
- 5/16" Socket wrench
- 21mm socket wrench
- 15mm socket wrench
- 10mm Socket wrench
- 8mm Socket wrench
- 7mm Socket wrench
- 9/16" Drill bit or step bit
- 5/16"-18 Tap
- 1/2"-13 Tap
- E6 External torx socket
- Panel pry tool
- Scissors
- Sharpie
- Scotch tape
- Snips

## ASSISTANCE

We recommend two people perform the installation as items are heavy and may need to be held in place while installing.

## ORGANIZATION

Disassemble the vehicle where you can catalog and store everything. We suggest labeling and bagging all the OEM bolts when removing from the vehicle. Failure to keep track of parts could lead to an inability to properly reinstall components.

# DISASSEMBLY

*NOTE: Save all OEM parts until installation is complete!*

**1. Using a panel pry tool, remove the fourteen (14) push pins. (Figure 1)**

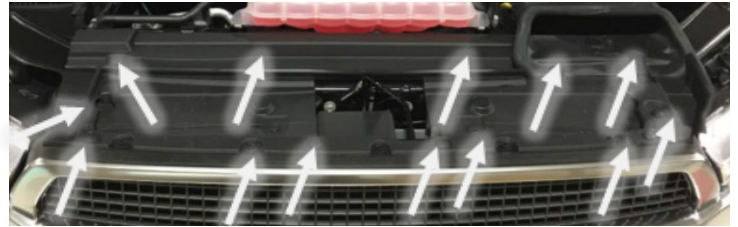

Figure 1

**2. Using a panel pry tool, remove the five (5) push pins and remove the radiator support trim. (Figure 2)**



Figure 2

**3. Using a 10mm socket wrench, remove the four (4) bolts securing the top of the grill to the radiator support. (Figure 3)**

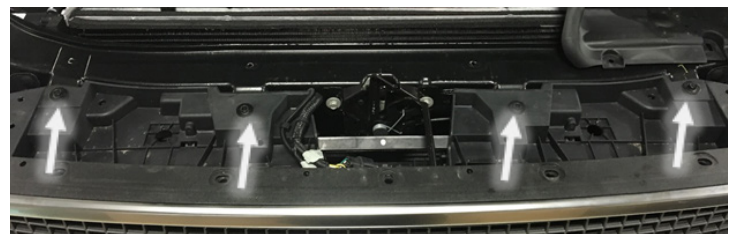

Figure 3

4. Using a 7mm socket wrench, remove the one (1) bolt from both fender flares. (Figure 4)



Figure 4

5. Using a panel pry tool, remove the three (3) front push pins from the underside of the fender flare on each side of the vehicle. (Figure 5)



Figure 5

6. Using a panel pry tool, unclip the front couple of the fender flare retainers from the fender allowing clearance for the lower grill valence to be removed from the vehicle.

7. Using a panel pry tool, remove the lower grill valence from the vehicle. (Figure 6)



Figure 6



8. Using a 10mm socket wrench, remove the two (2) bolts on each side of the grill. (Figure 7)



Figure 7

9. Remove the grill and the upper louver system from the vehicle. Be sure to unplug the harness from the grill assembly. (Figure 8)



Figure 8

10. Using a panel pry tool, remove the two (2) plastic bumper covers located on both the driver and passenger side of the bumper exposing the bumper bolts and adaptive cruise control sensor. (Figure 9)



Figure 9

**11. Using an E6 external torx socket wrench and 11mm socket wrench, remove the adaptive cruise control sensor mounted behind the driver side plastic bumper cover. (Figure 10)**

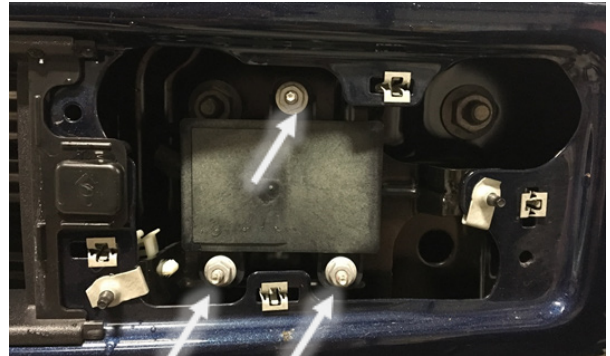

*Figure 10*

**12. Using a 21mm socket wrench, remove the three (3) factory nuts securing the front bumper to the frame rails on both driver and passenger side of the bumper. Disconnect the wiring harness and remove the front bumper. (Figure 11)**

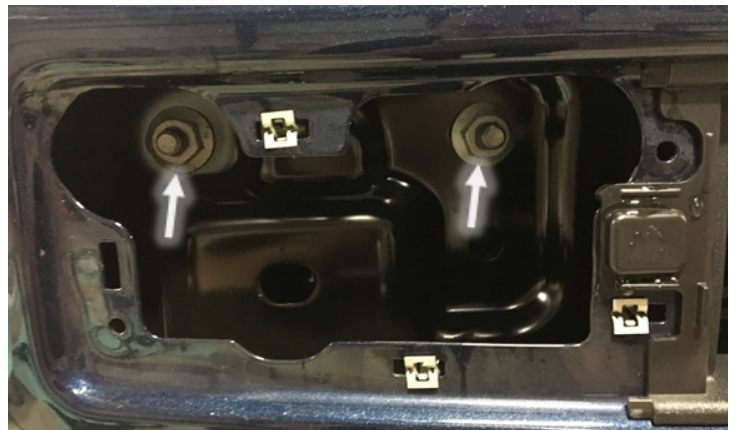

*Figure 11*

**13. Using a 15mm socket wrench, remove both tow hooks from the frame rails. (Figure 12)**



*Figure 12*

14. Using either a 9/16" drill bit or step drill, drill out all four (4) of the tow hook bolt holes to 9/16" hole.

15. Remove the plastic trim from the lower louver system by unclipping the plastic retainers on top and bottom of the louver assembly. (Figure 13)

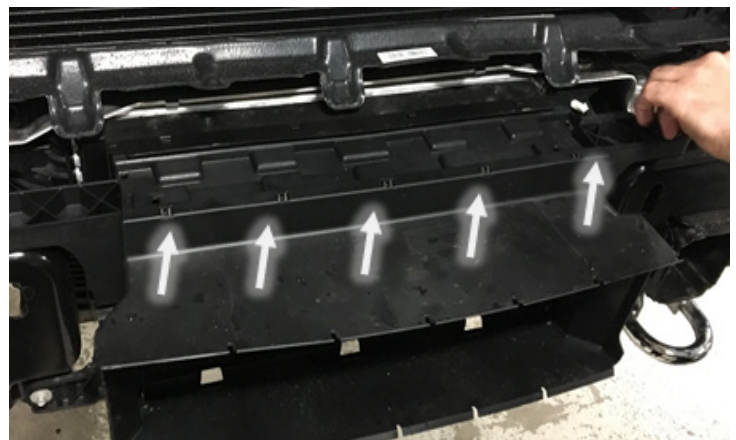

Figure 13

16. Using a panel pry tool, unclip the wiring harness from the top of the lower louver assembly. (Figure 14)

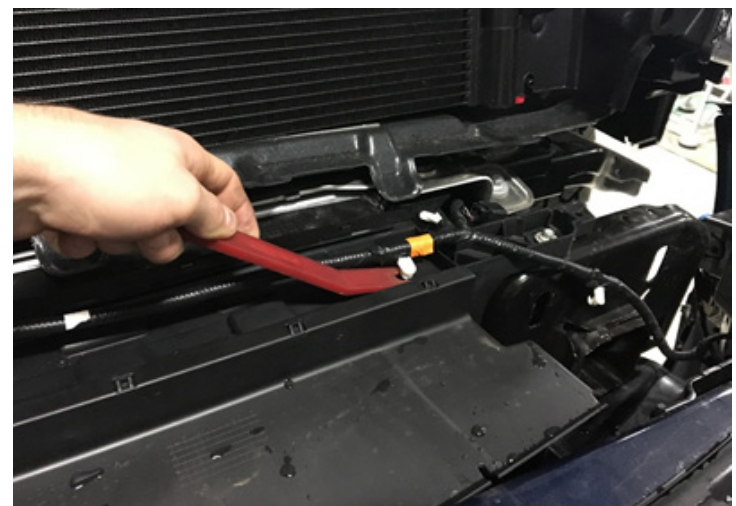

Figure 14

17. Using 8mm socket wrench, remove the four (4) bolts securing the lower louver assembly to the frame rails. (Figure 15)



Figure 15

18. Using a sharpie and cutting tool, mark the back of the louver assembly and trim off the excess plastic. (Figure 16-18)



Figure 16



Figure 17



Figure 18

19. Using an 8mm and 5/16" socket wrench, install the lower louver brackets (21614, 21615) to the top of the frame rail using the Oem bolts. Using the six (6) provided 1/4" x 1.00" yellow zinc hex bolts, flat washers, lock washer, and hex nut, fully tighten down the lower louver assembly to the brackets. (50206-HW) (Figure 19)



Figure 19

20. Using a 10mm socket wrench, remove the plastic air diverter by removing the three (3) bolts. (Figure 20,21)



Figure 20



Figure 21

**21. Reinstall the grill, valence, fender flares in a manner opposite of their removal as described in steps 9 back to 1. (Figure 22)**



*Figure 22*

# INSTALLATION

22. Using a 5/16"-18 and 1/2"-13 tap, chase the four (4) light box mounting nuts in the bumper (22031) and the four (4) bracket nuts on both brackets (22034, 22035). (Figure 23)



Figure 23

23. Loosely install both brackets (22034, 22035) to the bumper (22031) using the four (4) provided bolt strips (20296) and the provided 1/2"-13 yellow zinc hex nuts, yellow zinc flat washer, yellow zinc lock washer. (50206-HW) (Figure 24) **\*\*NOTE\*\*** The installation orientation of the bolt strips shown in figure 24 is important for proper clearance to the frame rail and the ability to tighten the hardware. **\*\***



Figure 24

24. Using a E6 external torx socket and 1/2" socket, insert and install the adaptive cruise control sensor into the bumper (22031). Use the two (2) provided M8 hex nuts to tighten the lower two studs. (50206-HW) (Figure 25)

**\*\*NOTE\*\*** Insertion of the sensor is made easy by first inserting the lower two studs into the opening while aligning them with the two holes, then rotating the upper part of the sensor into the opening while aligning the upper stud with the weld nut in the bracket **\*\***



Figure 25

**\*\*Note:** The sensor ultimately should be set to be perpendicular to the ground but a ½" gap between the sensor flange and bracket is a good starting position. (Figure 26)

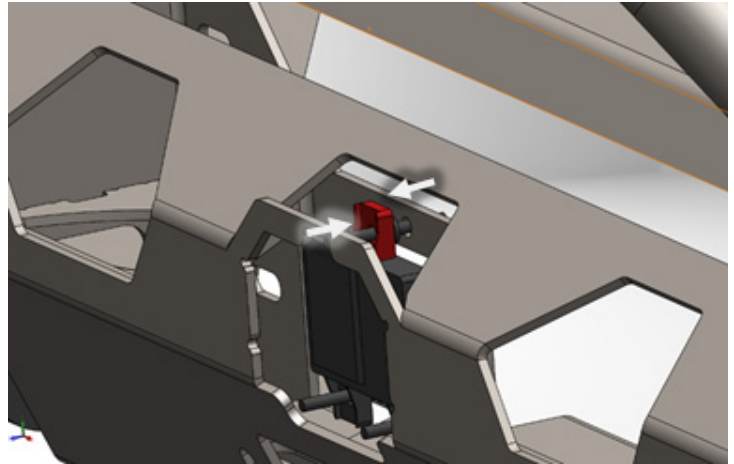

Figure 26

25. Using a pair of scissors, cut out the sensor cover template included on the last page of this manual.

**\*\*NOTE\*\*** Be sure to transfer the four (4) bolt notches from the template and trim the cover accordingly\*\* (Figure 27)

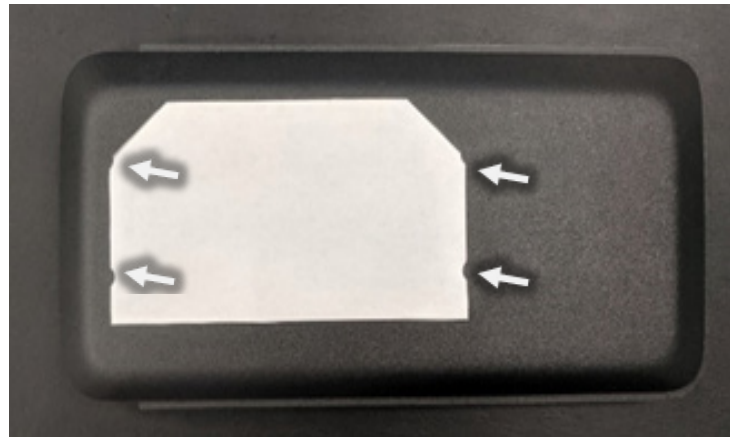

Figure 27 (front side shown)

26. Using the factory bumper cover, align the template as shown trying to avoid any plastic features on the back side of the cover. (Figure 27,28)

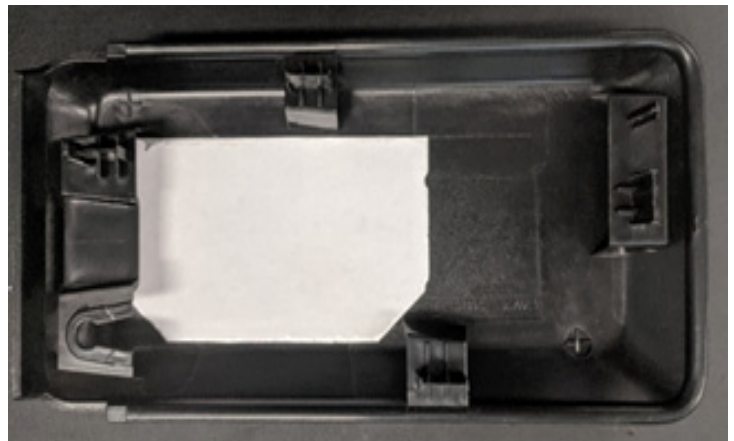

Figure 28 (Back side shown)



27. Using a sharpie and cutting tool, trace and cut the template shape. (Figure 29)

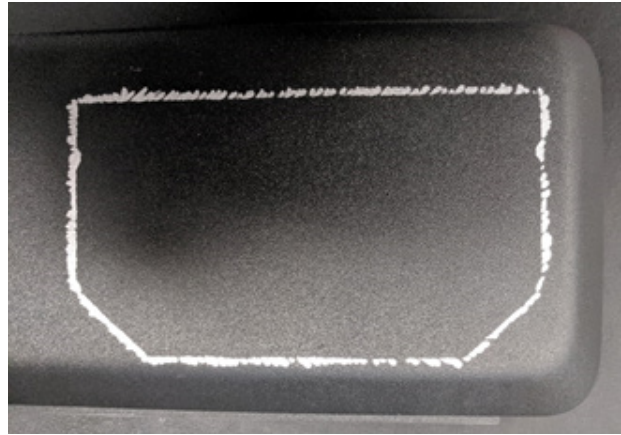

Figure 29

28. Using the provided #8 x 1.0" stainless steel button head screw and #8 flat washers, preassemble the sensor cover trim (22039), cut sensor cover, and hardware. (Figure 30)

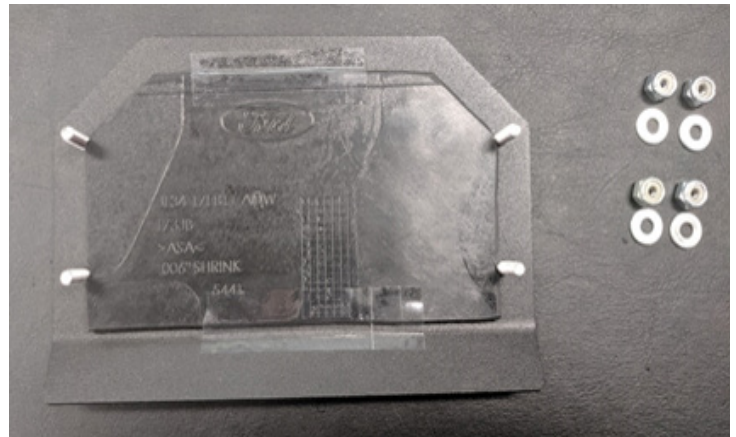
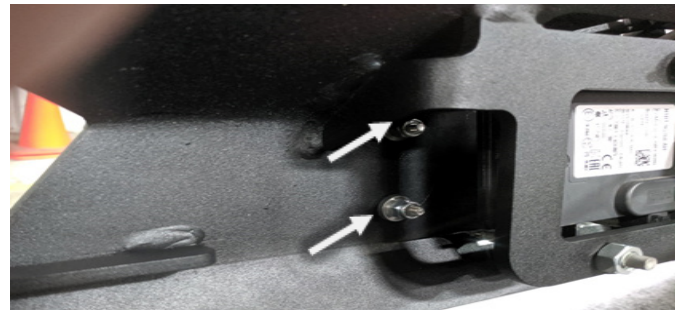

Figure 30

29. Align and center the cut sensor cover with the four bolts and secure the cover to the cover trim using scotch tape. (Figure 30)

**30. While holding all four (4) bolts from falling out, insert the sensor cover trim assembly through the four (4) bolt notches in the sensor opening of the bumper (22031). (Figure 31)**



*Figure 31*

**31. Using the provided #10 stainless steel rubber bonded washers and #8 stainless steel Nylock nut, secure the sensor trim assembly to the bumper (22031). (50206-HW) (Figure 32)**



*Figure 32*

**32. Plug the sensor wiring harness to the sensor. (Figure 33)**



*Figure 33*

**\*\*NOTE\*\*** Steps 33 thru 36 are only used if you are installing a 30" light bar and/or winch\*\*

33. Using the included "L" brackets (21871) and the two (2) ¼"-20 hex bolts, four (4) ¼" flat washers, two (2) ¼" lock washers, and two (2) ¼"-20 hex nuts (50206-HW), loosely install the "L" brackets to the inside of the bumper (22031) hand tight.

34. Using the factory hardware for the 30" light bar, securely tighten the light bar to the "L" brackets following the manufactures steps and recommended tools.

35. Using a pair of 7/16" wrenches, center the light bar and fully tighten the two (2) ¼"-20 bolt stacks. (Figure 34)

36. If applicable, fully install your winch into the bumper at this time while following the manufactures instructions and using the recommended tools and hardware.



*Figure 34*

37. Be sure to route the sensor wiring harness below the 30" light bar but above the winch

38. With assistance lift and set the bumper assembly up onto the frame rail ends while connecting the sensor wiring harness.

39. Using the four (4) provided ½"-13 yellow zinc hex bolts, yellow zinc flat washer, and yellow zinc lock washer, fully tighten down the brackets (22034, 22035) to the bottom of the frame rail on both driver and passenger side. (50206-HW) (Figure 35)

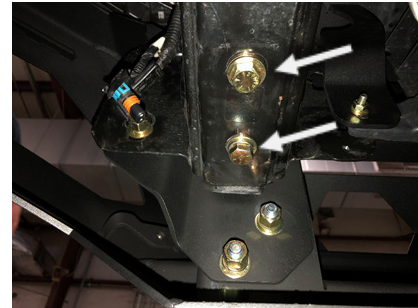

Figure 35

40. Using the four (4) provided ½"-13 yellow zinc hex bolts, yellow zinc flat washer, and yellow zinc lock washer, fully tighten down the brackets (22034, 22035) to the frame rail flange on both driver and passenger side. (50206-HW) (Figure 36)

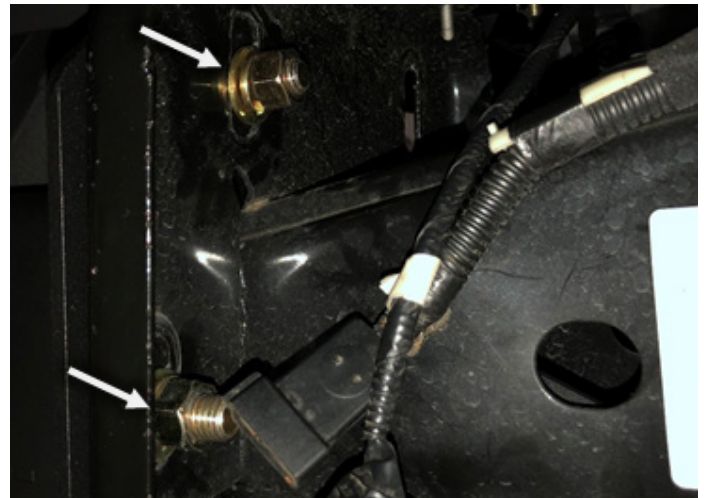

Figure 36

41. Center the bumper between the fender flares.

42. With assistance and while using a  $\frac{3}{4}$ " socket wrench, lift the bumper with a uniform gap up to the valance and fully tighten the stud plates (20296) securing the bumper (22031) to the brackets (22034, 22035). (Figure 37)



Figure 37 (shown off vehicle for clarity)

43. Using a  $\frac{1}{2}$ " socket wrench and the four (4) provided  $\frac{5}{16}$ " x 1.0" yellow zinc hex bolts, yellow zinc lock washers, stainless steel fender washers, fully install both driver and passenger side light boxes (22032, 22033) to the bumper (22031). (50206-HW) (Figure 38)



Figure 38 (shown off vehicle for clarity)

44. Installation is complete.

- Periodically check and tighten all fasteners.
- Stripped, fractured, or bent bolts or nuts need to be replaced



**\*\*Make sure that you validate the template measurements prior to cutting trim piece\*\*  
Measure twice, cut once\*\***

# SENSOR COVER TEMPLATE

