



INSTALLATION MANUAL
GRUMPER
PRODUCT NUMBER: GR4200
APPLICATION: 2019 DODGE RAM 1500



IMPORTANT SAFETY GUIDE | Your safety and the safety of others is very important.

In order to help you make informed decisions about safety, we have provided the following warnings, safety precautions, installation instructions, and other important information to alert you to potential hazards that could hurt you or others.

Please do a job safety analysis before each task to identify potential hazards for your situation and remove/protect against them. Use own good judgment and take your time.

Check packaged materials immediately upon arrival to ensure that all listed parts are included and undamaged.

Read and understand all warnings, safety precautions, and instructions before installing this product.

SENSORS FIELD OF VIEW WILL BE ALTERED WITH USE OF THE REPLACEMENT BUMPER.

WARNINGS

- Failure to observe the following warnings and instructions provided in this manual could lead to severe injury and/or death.
- For professional installation only. Careless installation and/or operation can result in serious injury, death, and/or equipment damage. All liability for installation and use rests with the user or consumer.
- Fab Fours, Inc. only approves installing this product according to these written instructions with the hardware provided. Failure to install according to these instructions will invalidate the warranty. This includes, but is not limited to, using alternative installation methods, hardware, or materials.
- This product is for off road use only.

SAFETY PRECAUTIONS

- Always remove jewelry and wear eye protection.
- Always use extreme caution when jacking up a vehicle for work. Set emergency brake and use tire blocks. Locate and use the vehicle manufacturers designated lifting points. Use jack stands.
- Always use appropriate and adequate care in lifting components into place.
- Always ensure components will remain secure during installation and operation.
- Always wear safety glasses when installing this kit. A drilling operation will cause flying metal chips. Flying chips can cause serious eye injury.
- Always use extreme caution when drilling a vehicle. Always disconnect power before welding. Thoroughly inspect the area to be drilled (on both sides of material when possible) prior to drilling, and relocate any objects that may be damaged.
- Always use extreme caution when welding a vehicle. Thoroughly inspect the area to be welded (on both sides of material when possible) prior to welding, and relocate any objects that may be a fire hazard. When welding in a cab, make sure the interior surfaces are covered (e.g., welding blanket) and a fire extinguisher is at hand.
- Always use extreme caution when cutting and trimming during fitting.
- Always tighten all nuts and bolts securely per installation instructions.
- Always route electrical cables carefully. Avoid moving parts, components that become hot, and rough or sharp edges.
- Always insulate and protect all exposed wiring and electrical terminals.
- Perform regular inspections and maintenance on mounts and hardware.

TABLE OF CONTENTS

2	SAFETY / DISCLAIMER
3	TABLE OF CONTENTS
4	A MESSAGE FROM THE OWNER
5	GETTING STARTED
6	PROVIDED MATERIAL
8	DISASSEMBLY
13	INSTALLATION
19	CONTACT

A MESSAGE FROM THE OWNER



Fab Fours' was born out of a passion for customizing vehicles and a love for the outdoors. Our engineering team uses the latest 3D design software to turn new product ideas into reality. In our factory, designs come to life with the combination of cutting edge technology for metal cutting and forming and an American workforce that puts its' heart and pride into every product.

From design and manufacturing, to quality and delivery, Fab Fours' mission is to be the market leader for steel truck and jeep accessories. We make sure a quality product is delivered on time, more than expected, better than expected to our customers.

Enjoy your new Fab Fours product. Welcome to the family!

Ereg Higgs

FOUNDER, FAB FOURS

GETTING STARTED

Before you begin the installation process of your new Fab Fours product, we suggest laying out all materials and parts on a pad or protective surface.

Failure to fully account for all components before beginning installation may leave vehicle immobile until part is acquired. Refer to the next pages as an inventory check.

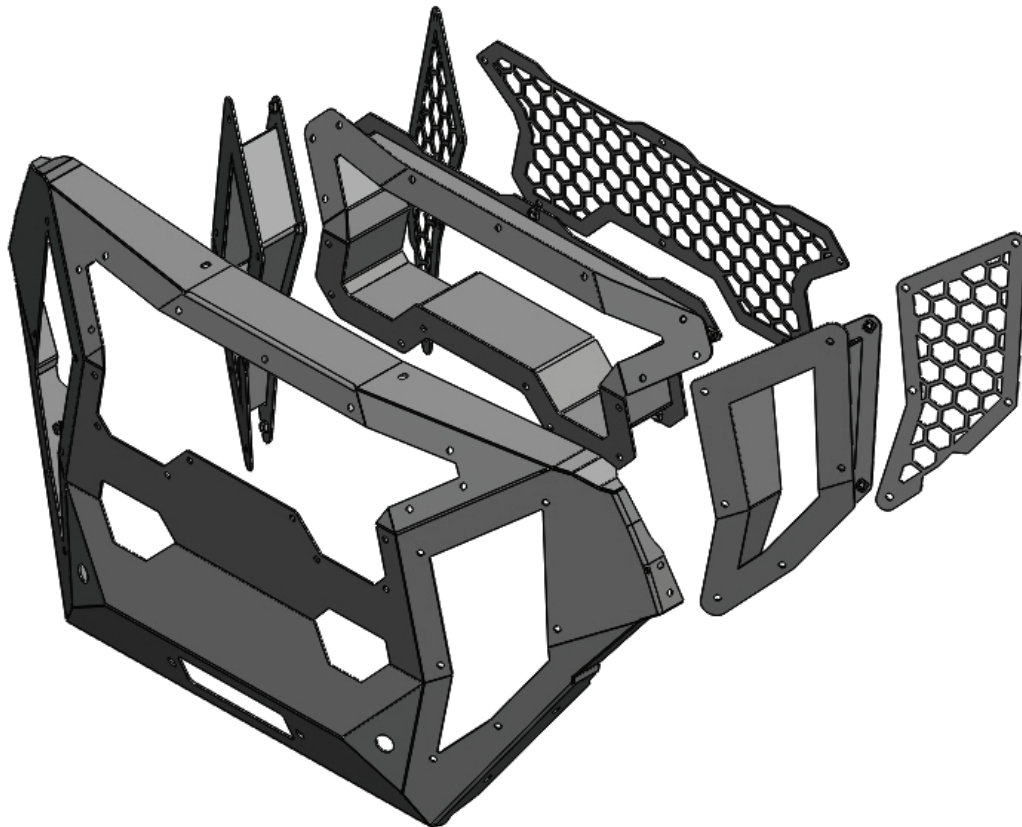

PROVIDED MATERIALS

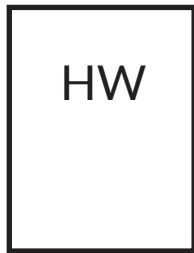

50125-HW

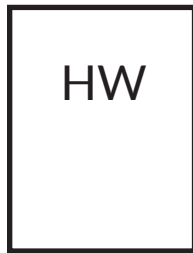

50168-HW



GR4200-IM

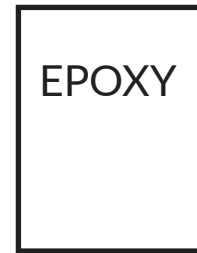

EPOXY

61632
QTY: 2

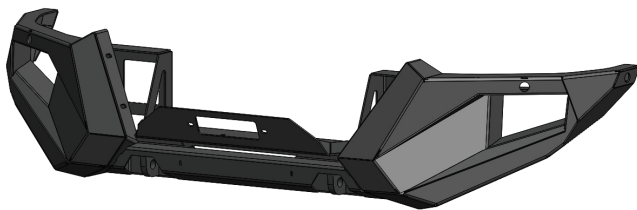

21789-W

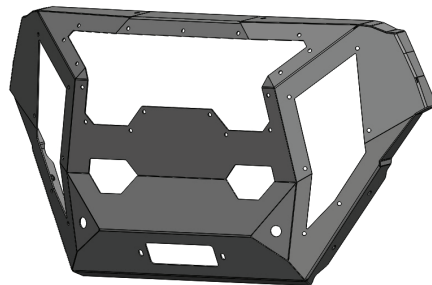

21790-W



21803-01
QTY: 2

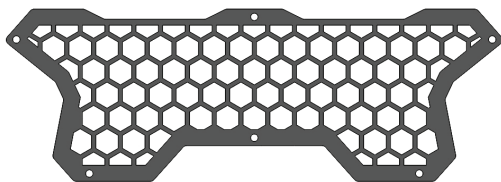

21791-01

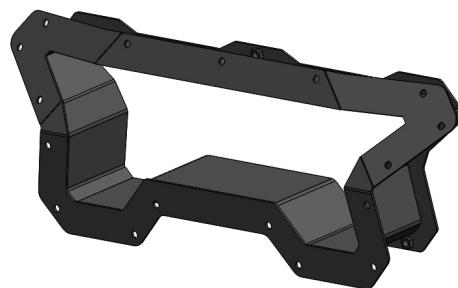

21794-W



21839-01



61713



21841-W

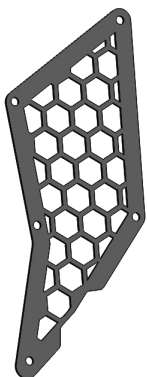

21792-01



21793-01

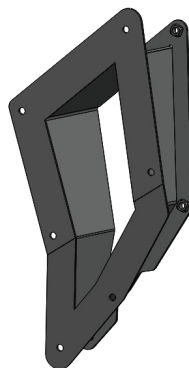

21795-W

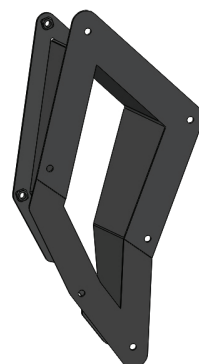

21796-W



21840-W

HARDWARE KIT | 50168

FAB FOURS IDENTIFICATION	COMPONENT DESCRIPTION	QTY
50168- HW	3/8"-16 7/8" Bolt, Yellow Zinc	16
50168- HW	3/8"-16 1" Bolt, Yellow Zinc	4
50168- HW	3/8"-16 Flat Washer, Yellow Zinc	20
50168- HW	3/8"-16 Lock Washer, Yellow Zinc	20
50168- HW	5/16"-18 Bolt, Yellow Zinc	8
50168- HW	5/16" Flat Washer, Yellow Zinc	16
50168- HW	5/16" Lock Washer, Yellow Zinc	8
50168- HW	5/16" Hex Nut, Yellow Zinc	8
50168- HW	7/16"-14 Bolt, Yellow Zinc	6
50168- HW	7/16"-14 Hex Nut, Yellow Zinc	6
50168- HW	7/16"-14 Lock Washer, Yellow Zinc	6
50168- HW	7/16"-14 Flat Washer, Yellow Zinc	12
50168- HW	1/2"-13 Bolt, Yellow Zinc	2
50168- HW	1/2" Lock Washer, Yellow Zinc	2
50168- HW	1/2" Flat Washer, Yellow Zinc	2

HARDWARE KIT | 50125

FAB FOURS IDENTIFICATION	COMPONENT DESCRIPTION	QTY
50125- HW	5/16"-18 Button Head Screw, Stainless Steel	29
50125- HW	5/16"-18 Finished Hex Nut, Stainless Steel	29
50125- HW	5/16" Split Lock Washer, Stainless Steel	29
50125- HW	5/16" Bonded Washer, Stainless Steel	29
50125- HW	5/16" Flat Washer, Stainless Steel	29
50125- HW	7/16" Flat Washer, Stainless Steel	4
50125- HW	7/16"-14 Fairlead Bolt, Stainless Steel	2
50125- HW	7/16"-14 Finished Hex Nut, Stainless Steel	2
50125- HW	7/16" Split Lock Washer, Stainless Steel	2

TOOLS REQUIRED

- 3/16" Allen Wrench
- 1/4" Allen Wrench
- 1/2" socket wrench
- 9/16" socket wrench
- 5/8" socket wrench
- 11/16" socket wrench
- 10mm socket wrench
- 18mm socket wrench
- Plastic panel pry tool
- Zip ties

ASSISTANCE

We recommend two people perform the installation as items are heavy and may need to be held in place while installing.

ORGANIZATION

Disassemble the vehicle where you can catalog and store everything. We suggest labeling and bagging all the OEM bolts when removing from the vehicle. Failure to keep track of parts could lead to an inability to properly reinstall components.

DISASSEMBLY

Note: Save all OEM parts until installation is complete!

1. Using a 10mm socket wrench, remove the five (5) 10mm OEM bolts located under both the passenger side and driver side wheel wells. Once the bolts have been removed, remove the plastic wheel well cover from the vehicle. (Figure 1-2)



Figure 1



Figure 2

2. Locate the harness plug on the driver side of the vehicle and disconnect it. (Figure 3)

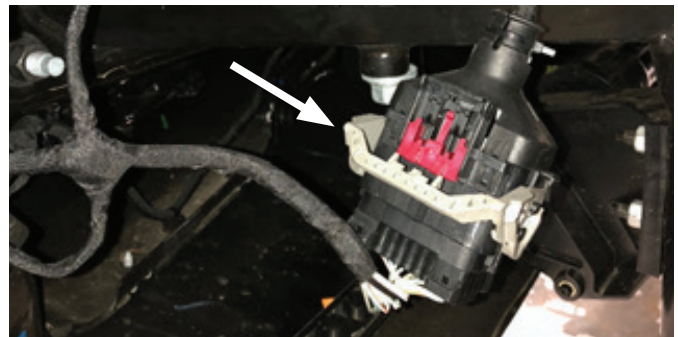

Figure 3

3. Using an 18mm socket wrench, remove the six (6) OEM nuts from the frame rails to disconnect the bumper from the truck. (Figure 4)

4. Remove the OEM bumper from the truck and set it aside.

5. Remove the OEM electrical harness from bumper by removing the push pins. (Figure 5-6)

Note: Document the location of each sensor housing for reference when reinstalling into your bumper.

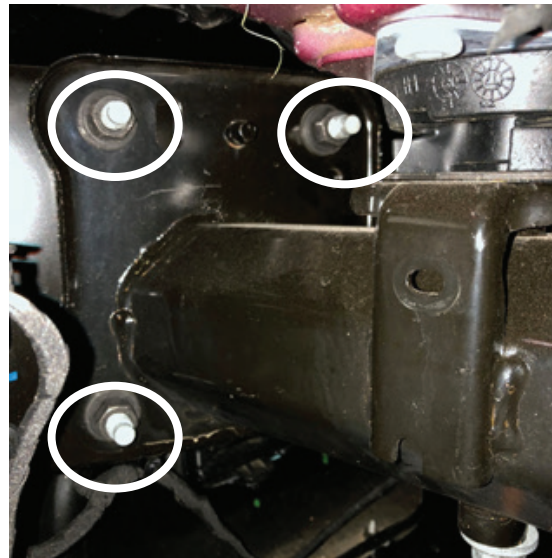

Figure 4



Figure 5



Figure 6

6. Disconnect the electrical harness from the fog lights in the bumper. (Figure 7)



Figure 7

7. Remove the sensor from the sensor housing by expanding both sides of the sensor housing and lift up. (Figure 8-9)

Note: Sensors are extremely delicate and must be handled with care! Do not push on face of sensors to remove!



Figure 8



Figure 9

8. Remove the sensor housing from the bumper by depressing the four (4) tabs while pulling outward from the outside of the bumper. (Figure 10-11)



Figure 10

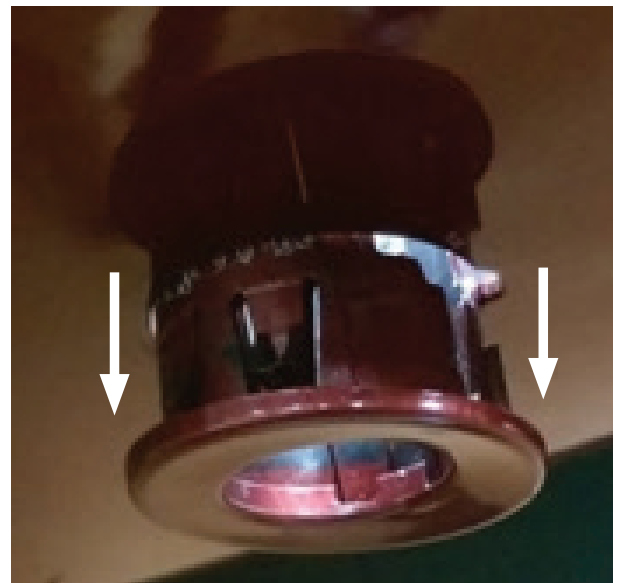

Figure 11

9. Using a plastic panel pry tool, remove the twelve (12) push pins located around the top of the grill cover and remove the grill cover from the truck. (Figure 12)



Figure 12

10. Using a 10mm socket wrench and plastic panel pry tool, remove the sixteen (16) bolts and the two (2) push pins around the grill to remove the header assembly. (Figure 13)

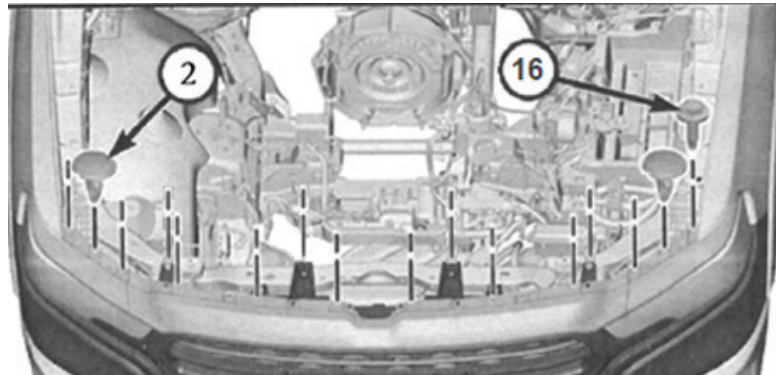

Figure 13

11. Using a 10mm socket wrench and plastic panel pry tool, remove the six (6) bolts and two (2) push pins in both the driver and passenger side wheel wells to allow access to the fender trim mounts. (Figure 14)

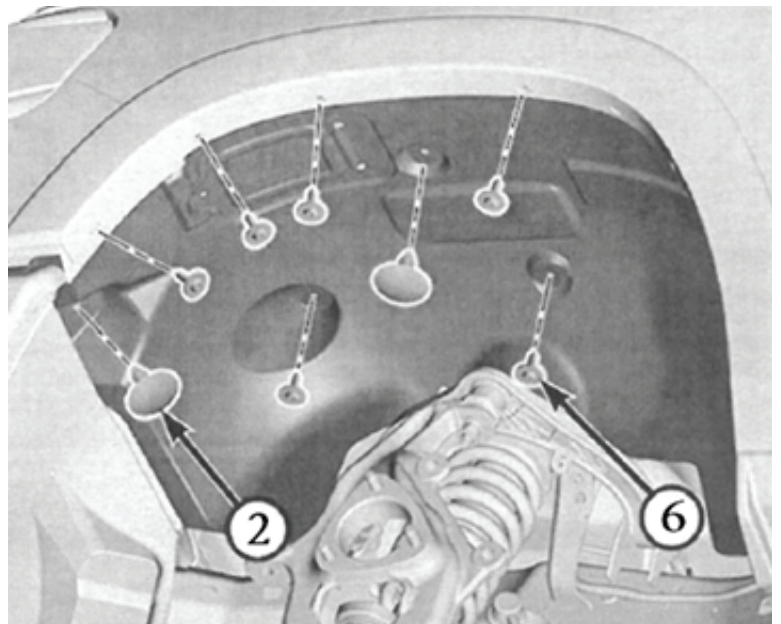

Figure 14

12. Using a plastic panel pry tool, remove the fender trim from the vehicle. From the inside of the fender, using a 10mm socket wrench, remove the OEM bolt connecting the fascia trim to the fender and a plastic panel pry tool to remove the fascia from the vehicle. (Figure 15-16)

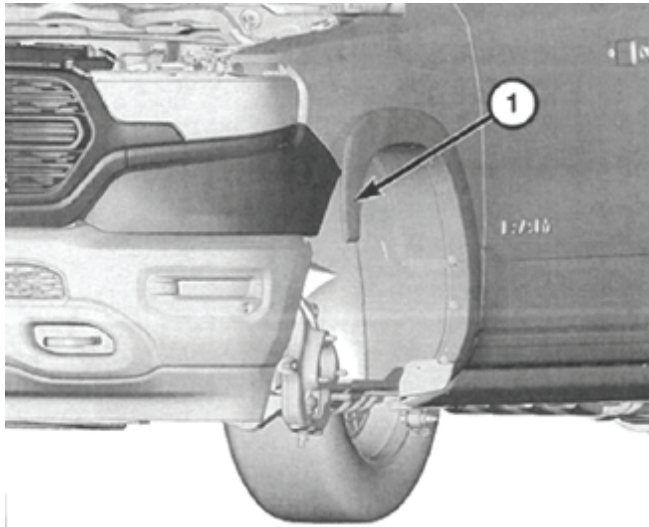

Figure 15

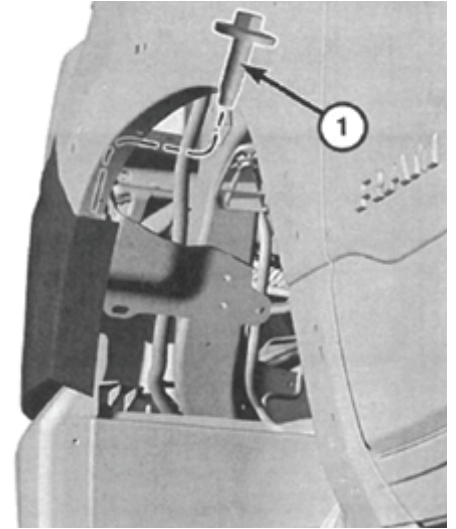

Figure 16

13. Once the fascia has been removed, use a 10mm socket wrench to remove the three (3) 10mm bolts on each side of the grill. The grill is now free to be removed from the vehicle. (Figure 17)

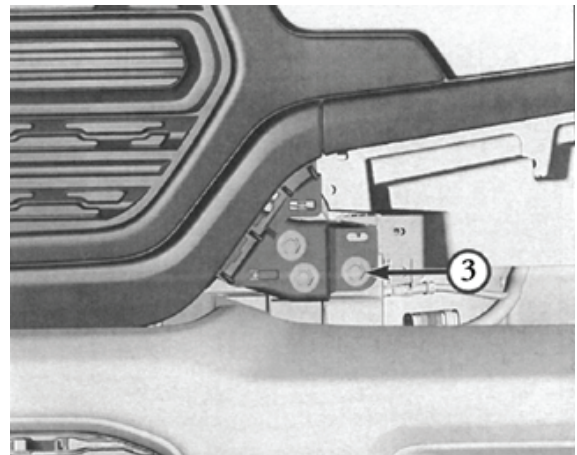

Figure 17

INSTALLATION

NOTE: Use painters' tape to protect any areas of the vehicle that may contact the Fab Fours product during installation.

NOTE: If installing any lights into the bumper, they can be installed prior to bumper installation. Follow the lighting manufacturer's instructions for installation.

1. Using a 10mm socket wrench, reinstall the OEM bolt connecting the fascia trim to the fender removed in step 12 of the disassembly section.
2. Install fender trim back on the vehicle removed in step 12 of the disassembly section.
3. Using a 10mm socket wrench, install the six (6) bolts and two (2) push pins in both the driver and passenger side wheel wells removed in step 11 of the disassembly section.
4. Using a 3/16" allen wrench and 1/2" socket wrench, attach the insert boxes (21795-W, 21796-W) to the grill with the provided twenty-nine (29) 5/16" Stainless steel bolts, rubber bonded washers, flat washers and nuts. (50125-HW) (Figure 18)



Figure 18

5. Using a 9/16" socket wrench, attach the provided mesh inserts (21791-01, 21792-01, 21793-01) to the insert boxes with the provided sixteen (16) 3/8" yellow zinc bolts, flat washers and lock washers. (50168-HW) (Figure 19)

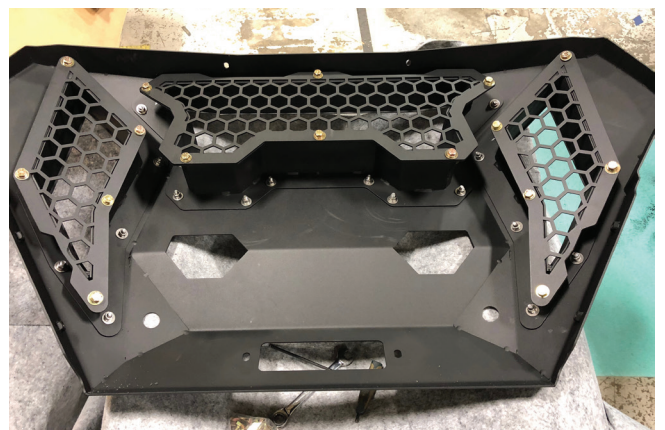

Figure 19

6. If truck is equipped with front camera, remove it from the OEM grill at this point to install it into the grill mesh. To remove the camera from its plastic mounting, push back the tab to release the locking mechanism. (Figure 20)



Figure 20

7. Once the camera is out of its housing, use the provided epoxy resin (Epoxy #61632) to attach the housing to the camera mounting bracket. (21839-01) (Figure 21)

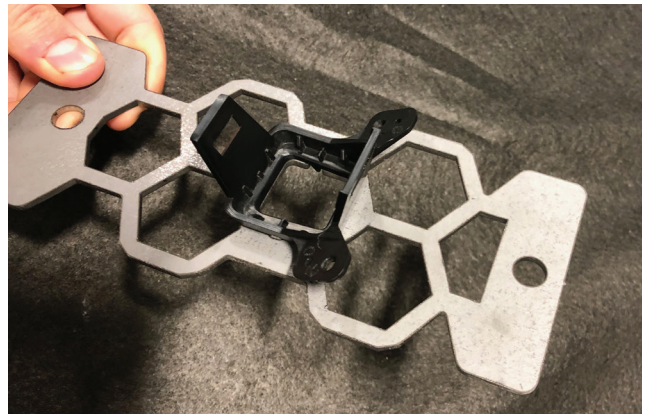

Figure 21

8. After the epoxy has hardened, place the camera back into its housing in the mounting bracket. Using a 9/16" socket wrench, fasten the camera mounting bracket to the center grill mesh using two (2) of the 3/8" yellow zinc mesh bolts installed in step 2 of the installation section. (Figure 22)

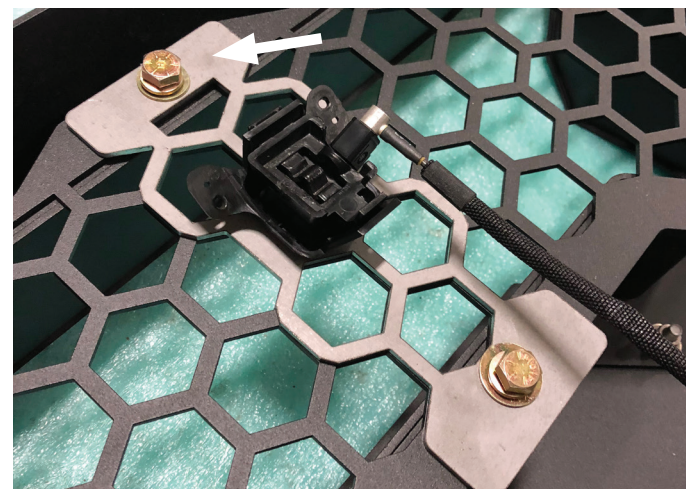

Figure 22

9. If your truck is equipped with the new style headlight, using a 1/2" socket wrench, attach the headlight fill brackets (21840, 21841) to the side of the grill using the two (2) 5/16" yellow zinc bolts, flat washers, lock washers and nuts provided in the hardware kit. (50168-HW) If you have the old-style lights these pieces can be discarded. (Figure 23-24)



Figure 23



Figure 24

10. Using a 1/2" socket wrench, loosely install the provided upper grill stiffeners (21803) to the top of the grill using the provided one (1) 5/16" yellow zinc bolts, flat washers, lock washers and nuts. (50168-HW) (Figure 25)

11. Place the Grumper face down to install the OEM sensor housings and harness.

NOTE: Make sure the harness plug is on the Driver side of the bumper when installing.



Figure 25

12. Install the sensor housings into the appropriate slots by inserting each housing from the outside of the bumper in. Make sure that the plug is on the driver side of the bumper. (Figure 26)



Figure 26

13. Replace the sensors in the appropriate housings and zip-tie any loose harness to the bumper. (Figure 27-28)

Note: Two (2) of the sensors will be in the grill section of the Grumper. Place the appropriate sensor housings into the grill for when the grill is installed.



Figure 27

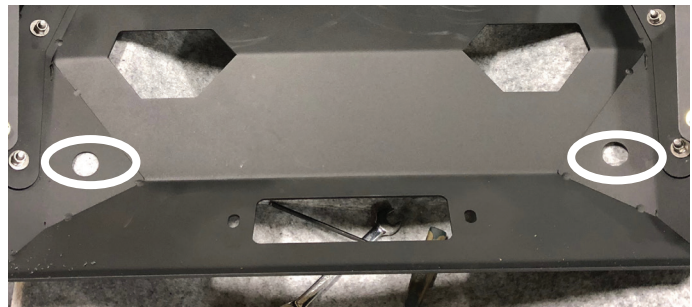

Figure 28

14. With assistance, hold the bumper to the frame. Using a 5/8" and 11/16" socket wrench, loosely install the bumper to the top portion of the frame with the provided six (6) 7/16" yellow zinc bolts, flat washers, lock washers and nuts. (50168-HW) (Figure 29)

15. Using the 3/4" socket wrench, fasten the third lower frame mount using the provided two (2) 1/2" yellow zinc bolts, flat washers and lock washers. (50168-HW) (Figure 29)



Figure 29

16. Adjust your bumper to the desired location on the truck. Using a 5/8", 11/16" and 3/4" socket wrench, fully tighten all mounting bolts.

17. Connect the sensor harness plug on the driver side of the truck. (Figure 30)



Figure 30

18. Using an 11/16" socket wrench and 1/4" allen wrench, mount the grill to the bumper using the provided two (2) 7/16" stainless steel fairlead bolts, flat washers, split lock washers and nuts. (50125-HW) (Figure 31)

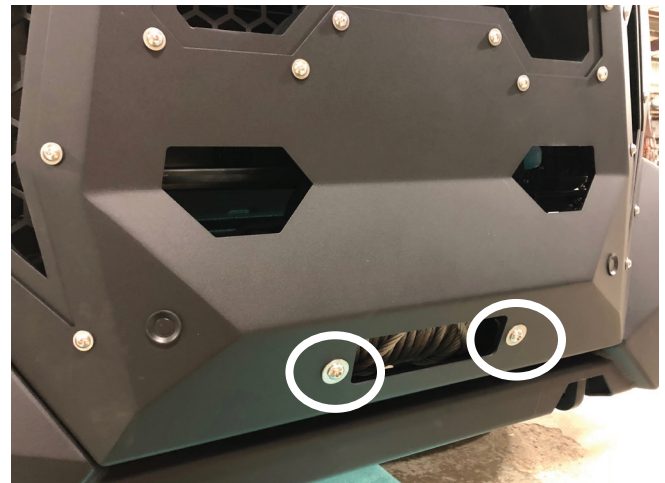

Figure 31

19. Using a 10mm socket wrench, reinstall the OEM 10mm bolts removed in step 10 of the disassembly section to fasten the upper grill stiffeners to the radiator mount. (Figure 32)



Figure 32

20. Using a 9/16" socket wrench, install the grill to the bumper on the driver and passenger side using the provided four (4) 3/8" yellow zinc bolts, flat washers and lock washers. (50168-HW) (Figure 33)



Figure 33

21. Using a 1/2" socket wrench, install the head assembly removed in step 10 of the disassembly section to the top of the grill with the provided two (2) 5/16" yellow zinc bolts, flat washers, lock washers and nuts. (50168-HW) (Figure 34)



Figure 34

22. Using a 10mm socket wrench, fasten the outsides of the header assembly using six (6) OEM 10mm bolts and push pins taken removed in step 10 of the disassembly section. (Figure 35)



Figure 35

23. Install the grill cover removed in step 9 of the disassembly section using the twelve (12) OEM push pins. (Figure 35)