



INSTALLATION MANUAL
MATRIX FRONT BUMPER
PRODUCT NUMBER: X365X
APPLICATION: 2016+ TOYOTA TACOMA



IMPORTANT SAFETY GUIDE | Your safety and the safety of others is very important.

In order to help you make informed decisions about safety, we have provided the following warnings, safety precautions, installation instructions, and other important information to alert you to potential hazards that could hurt you or others.

Please do a job safety analysis before each task to identify potential hazards for your situation and remove/protect against them. Use own good judgment and take your time.

Check packaged materials immediately upon arrival to ensure that all listed parts are included and undamaged.

Read and understand all warnings, safety precautions, and instructions before installing this product.

SENSORS FIELD OF VIEW MAY BE ALTERED WITH USE OF THE REPLACEMENT BUMPER.

WARNINGS

- Failure to observe the following warnings and instructions provided in this manual could lead to severe injury and/or death.
- For professional installation only. Careless installation and/or operation can result in serious injury, death, and/or equipment damage. All liability for installation and use rests with the user or consumer.
- Fab Fours, Inc. only approves installing this product according to these written instructions with the hardware provided. Failure to install according to these instructions will invalidate the warranty. This includes, but is not limited to, using alternative installation methods, hardware, or materials.
- This product is for off road use only.

SAFETY PRECAUTIONS

- Always remove jewelry and wear eye protection.
- Always use extreme caution when jacking up a vehicle for work. Set emergency brake and use tire blocks. Locate and use the vehicle manufacturers designated lifting points. Use jack stands.
- Always use appropriate and adequate care in lifting components into place.
- Always ensure components will remain secure during installation and operation.
- Always wear safety glasses when installing this kit. A drilling operation will cause flying metal chips. Flying chips can cause serious eye injury.
- Always use extreme caution when drilling a vehicle. Always disconnect power before welding. Thoroughly inspect the area to be drilled (on both sides of material when possible) prior to drilling, and relocate any objects that may be damaged.
- Always use extreme caution when welding a vehicle. Thoroughly inspect the area to be welded (on both sides of material when possible) prior to welding, and relocate any objects that may be a fire hazard. When welding in a cab, make sure the interior surfaces are covered (e.g., welding blanket) and a fire extinguisher is at hand.
- Always use extreme caution when cutting and trimming during fitting.
- Always tighten all nuts and bolts securely per installation instructions.
- Always route electrical cables carefully. Avoid moving parts, components that become hot, and rough or sharp edges.
- Always insulate and protect all exposed wiring and electrical terminals.
- Perform regular inspections and maintenance on mounts and hardware.

TABLE OF CONTENTS

- 2 SAFETY / DISCLAIMER
- 3 TABLE OF CONTENTS
- 4 A MESSAGE FROM THE OWNER
- 5 GETTING STARTED
- 6 PROVIDED MATERIAL
- 7 DISASSEMBLY
- 15 INSTALLATION
- 18 CONTACT

A MESSAGE FROM THE OWNER



Fab Fours' was born out of a passion for customizing vehicles and a love of the outdoors. Our engineering team uses the latest 3D design software to turn new product ideas into reality. In our factory, designs come to life with the combination of cutting edge technology for metal cutting and forming and an American workforce that puts its' heart and pride into every product.

From design and manufacturing, to quality and delivery, Fab Fours' mission is to be the market leader for steel truck and jeep accessories. We make sure a quality product is delivered on time, more than expected, better than expected to our customers.

Enjoy your new Fab Fours product. Welcome to the family!

Ereg Higgs

FOUNDER, FAB FOURS

GETTING STARTED

Before you begin the installation process of your new Fab Fours product, we suggest laying out all materials and parts on a pad or protective surface.

Failure to fully account for all components before beginning installation may leave vehicle immobile until part is acquired. Refer to the next pages as an inventory check.

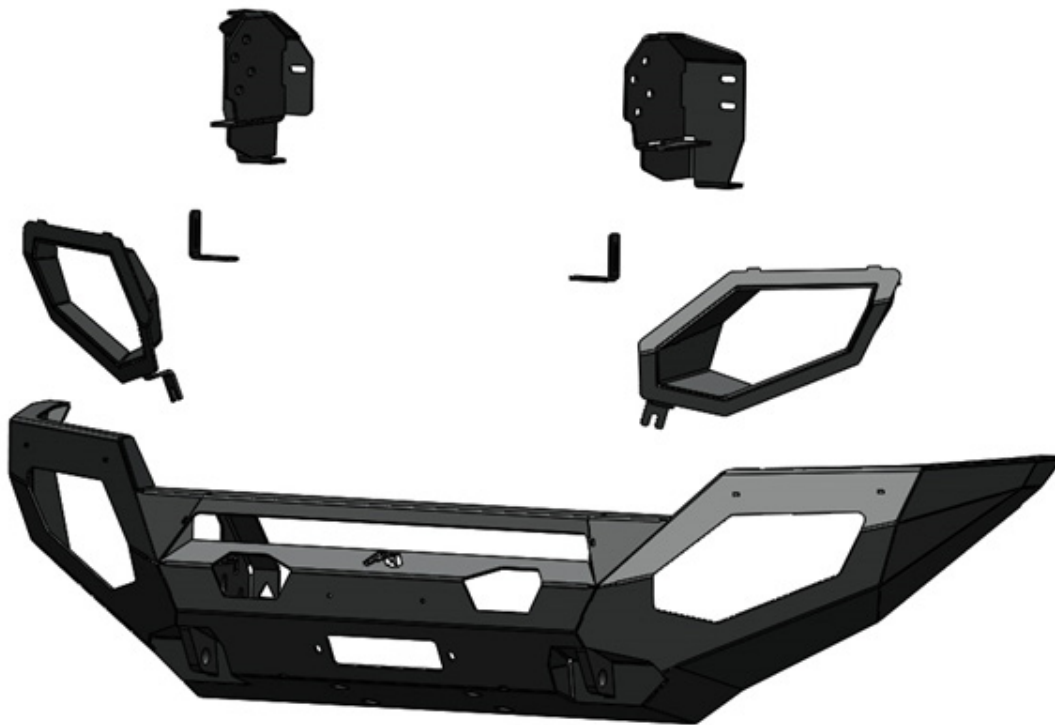

PROVIDED MATERIALS



TOOLS REQUIRED

- 5/16" Socket wrench
- 3/8" Socket wrench
- 3/4" Socket wrench
- 5/16" Open-end wrench
- 10mm Socket wrench
- 14mm Socket wrench
- 17mm Socket wrench
- Needle nose pliers
- Flat head screwdriver
- Plastic panel pry tool
- Silver Sharpie
- Small reciprocating saw
- Angle grinder w/ flat disk pad
- Painters tape

ASSISTANCE

We recommend two people perform the installation as items are heavy and may need to be held in place while installing.

ORGANIZATION

Disassemble the vehicle where you can catalog and store everything. We suggest labeling and bagging all the OEM bolts when removing from the vehicle. Failure to keep track of parts could lead to an inability to properly reinstall components.

HARDWARE KIT | 50203

FAB FOURS IDENTIFICATION	COMPONENT DESCRIPTION	QTY
50203-HW	1/4"-20 x 1", Yellow-zinc, GR8, Hex head cap screw	2
50203-HW	1/4"-20, Yellow-zinc, GR8, Hex nut	2
50203-HW	1/4", Yellow-zinc, GR8 Flat washer	4
50203-HW	1/4", Yellow-zinc, GR8 Lock washer	2
50203-HW	5/16"-18 x 1.0", Yellow-zinc, GR8 Hex head cap screw	2
50203-HW	5/16"m Stainless steel, Flat fender washer	2
50203-HW	5/16"Yellow-zinc, GR8 Lock washer	2
50203-HW	1/2", Yellow-zinc, GR8 Flat washer	8
50203-HW	1/2", Yellow-zinc, GR8 Lock washer	8
50203-HW	1/2"-13, Yellow-zinc, GR8 Lock washer	8

DISASSEMBLY

NOTE: Save all OEM parts until installation is complete!

1. Using a 10mm socket wrench, remove the two (2) screws holding the grille to the core support. (Figure 1)



Figure 1

2. Using a plastic body panel pry tool, remove the push lock clip from the outer edge of the grille on either side near the headlights. To release these clips, lift up on the center portion and then pull the whole clip upwards. With the clips removed, pull firmly outward on the grille shell and it should pop loose. (Figure 2)



Figure 2

3. Using a 10mm socket wrench, remove the nine (9) screws attaching the black plastic valance to the lower portion of the bumper cover on the outside. (Figure 3)



Figure 3

4. Using a 10mm socket wrench, remove the three (3) screws attaching the black plastic valance and inner fender to the lower portion of the bumper cover on the inside of each side of the vehicle. (Figure 4)

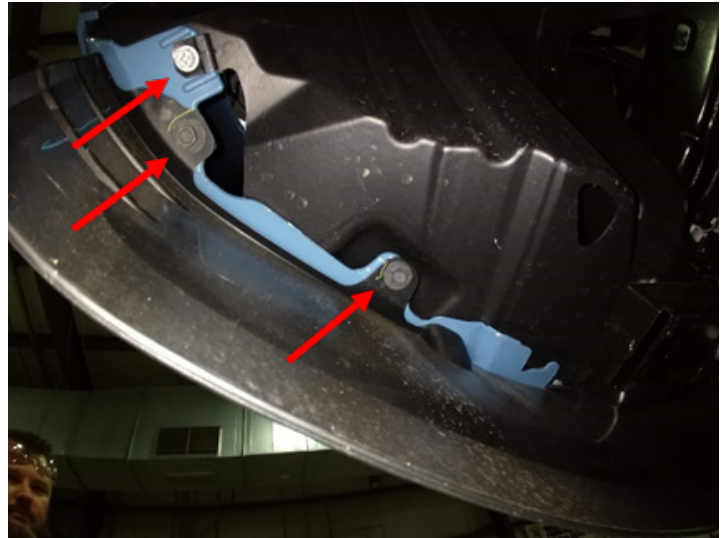

Figure 4

5. Using a 10mm socket wrench, remove the two (2) screws at the bottom center of the bumper cover. (Figure 5)



Figure 5

6. Using a 10mm socket wrench and a flat head screwdriver, remove the screw and the twist lock clip attaching the inner fender to the bumper cover. (Figure 6)



Figure 6

7. Using a plastic body panel pry tool, remove the six (6) push lock clips from the top of the bumper cover. (Figure 7)



Figure 7

8. Using a plastic body panel pry tool, reach inside the bumper cover and pinch the two (2) clips holding the flare to the bumper cover and pull out on the flare. With the flares pulled out of the cover remove the bumper cover from the vehicle. (Figure 8)



Figure 8

9. Using a 14mm socket wrench, remove the three (3) nuts per side holding the impact bar to the core support. (Figure 9)

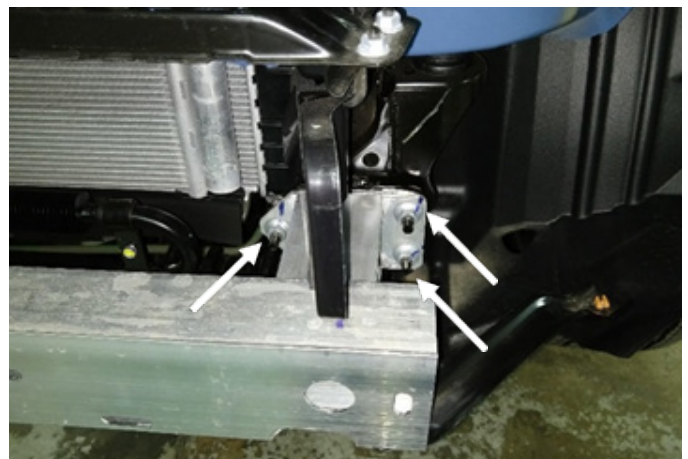

Figure 9

10. Using a pair of needle nose pliers, remove the plastic captured nut from the inner fender and support bar. Remove the impact bar from the vehicle. (Figure 10)

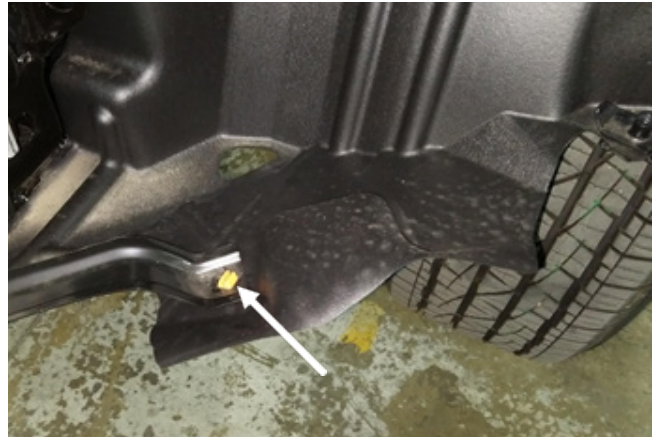

Figure 10

11. Using a 17mm socket wrench, remove the screw on either end of the bottom of the core support. Leave the crash bars in place. (Figure 11)

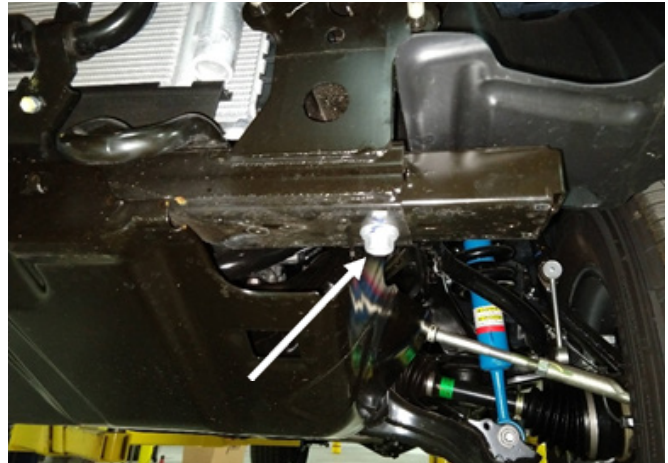

Figure 11

12. Using a plastic body panel pry tool, remove the push lock clip holding the air dams on either side of the radiator then pull. (Figure 12)



Figure 12

13. Using a silver sharpie and a body saw, mark and cut a line on the bumper cover bracket at the edge of the fender. (Figure 13)

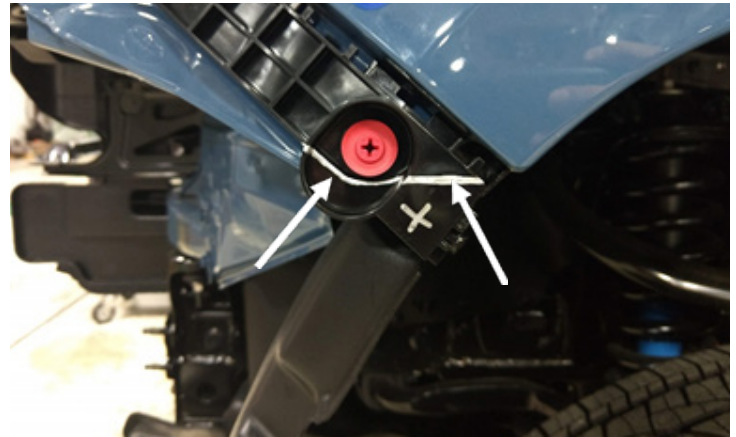

Figure 13

14. Using painters' tape and a body saw, mark and cut the inner fender following the profile of the body in front of the wheel. Remove any rough edges using an angle grinder with flap disk pad. (Figure 14)



Figure 14

15. If installing lighting into the wings of your matrix bumper, do so now following the lighting manufactures instructions.

16. If installing a winch into your matrix bumper, do so now per the manufacturer's instructions using the provided hardware that came with your winch.

17. If installing lighting into the center portion of your matrix bumper, do so now using the two (2) provided "L" shaped brackets (21871-10) and 1/4" grade 8 bolts, washers, and nuts (50203-HW) with 5/16" socket and open-end wrenches. (Figure 15)

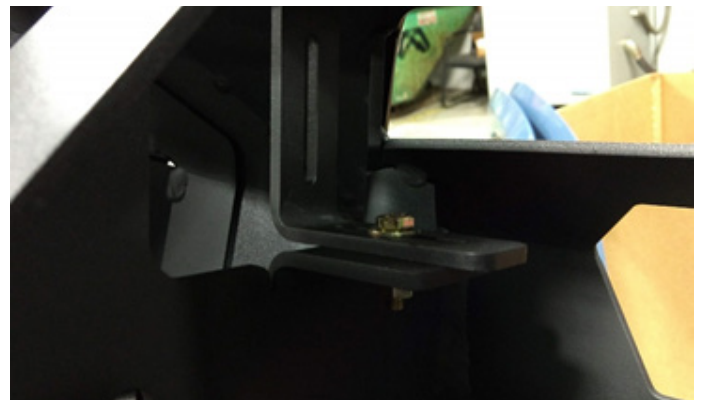

Figure 15

18. Holding the bumper cover up the vehicle, use painters' tape to cover the upper portions of the bumper cover in preparation for being cut. (Figure 16)



Figure 16

19. Using a silver sharpie and a tape measure, scribe a straight line on the bumper cover connecting the bottom of the opening around the fog light and the bottom corner of the fender. (Figure 17)

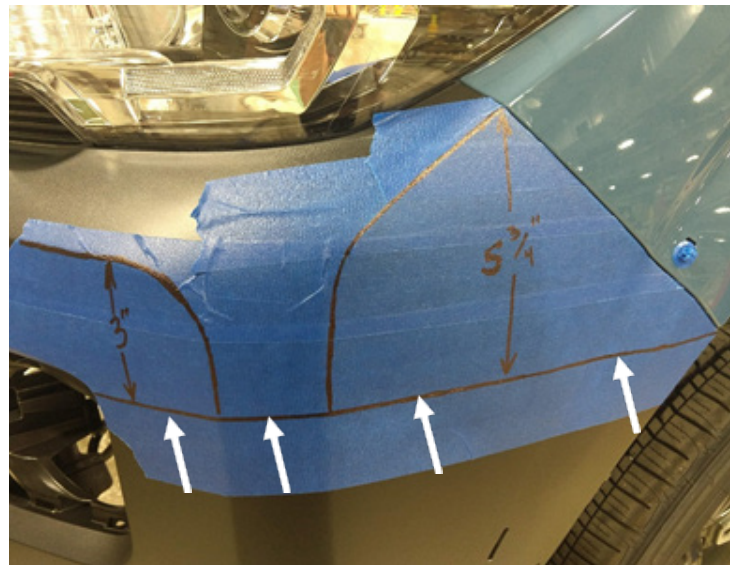

Figure 17

20. Using painters' tape and a silver sharpie, cover and mark the fender flare inline with the mark made in step 19. (Figure 18)

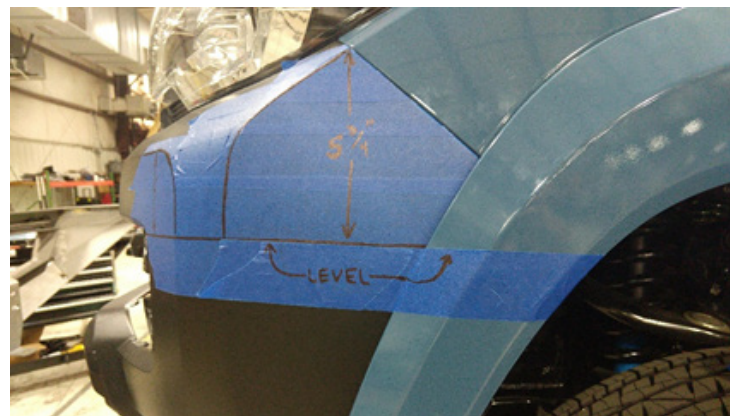

Figure 18

21. Using a silver sharpie, mark the bumper cover above the fog light pocket. (Figure 19)

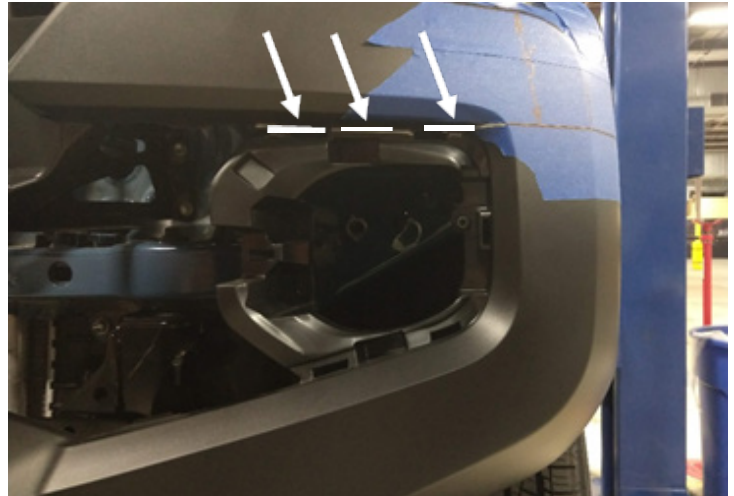

Figure 19

22. Using a body saw, cut roughly 1/8" below the lines made in steps 19-21. (Figure 20)



Figure 20

23. Using an angle grinder with a flap disk pad, remove the rest of the material up to the marks made in steps 19-21 and to remove any roughness created by the body saw.

24. Reinstall the cut bumper cover and grille at this point by reversing the steps used earlier to remove them.

25. Using a 1/2" socket wrench, one (1) of the provided 5/16" screws, fender washers, and lock washers (50203-HW) install the provided light box (22022) into the driver side of the bumper. (Figure 21,22)



Figure 21

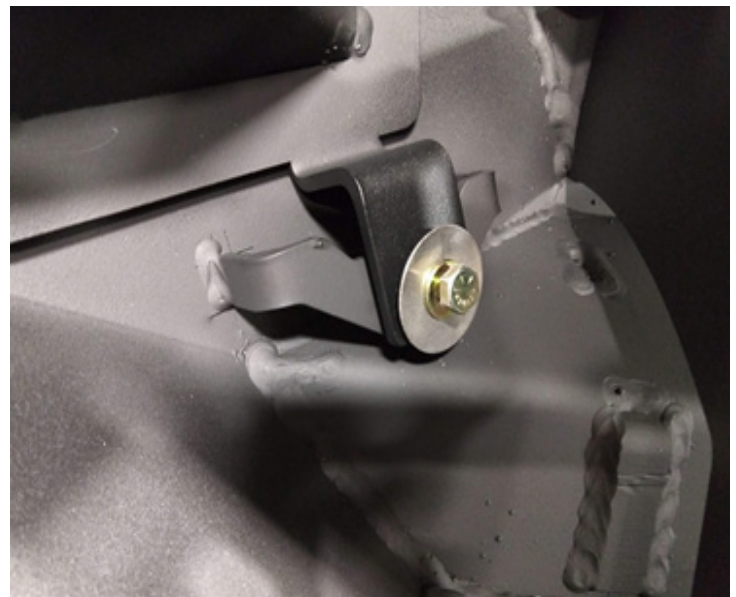

Figure 22

26. Repeat step 25 on the passenger side of the bumper with the provided passenger side light box (22023).

INSTALLATION

27. Reusing the OEM hardware removed in steps 9 and 11, loosely install the driver side intermediate bracket (22024) onto the vehicle frame. (Figure 23,24)



Figure 23

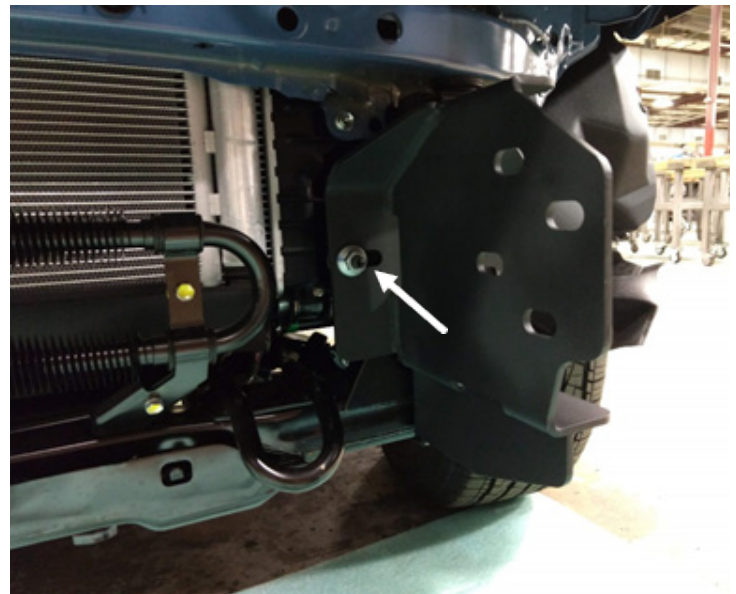

Figure 23

28. Repeat step 27 on the passenger side of the vehicle with the provided intermediate bracket (22025).

29. With assistance, place the bumper shell (22021) up to the vehicle and install the four (4) provided bolt strips (20296) through the winch tray mounting holes into the intermediate brackets. (Figure 25)

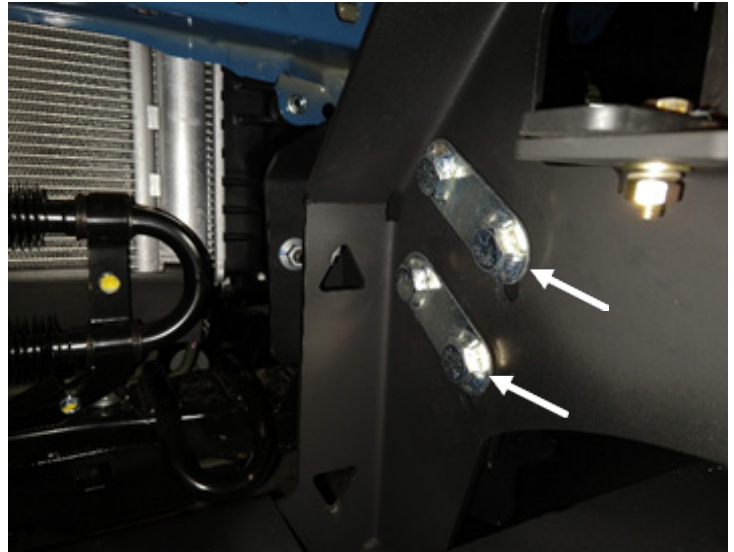

Figure 25

30. Loosely install four (4) of the provided 1/2" yellow-zinc grade 8 nuts, flat washers, and lock washers (50203-HW) per side onto the previously installed bolt strips. (Figure 26)

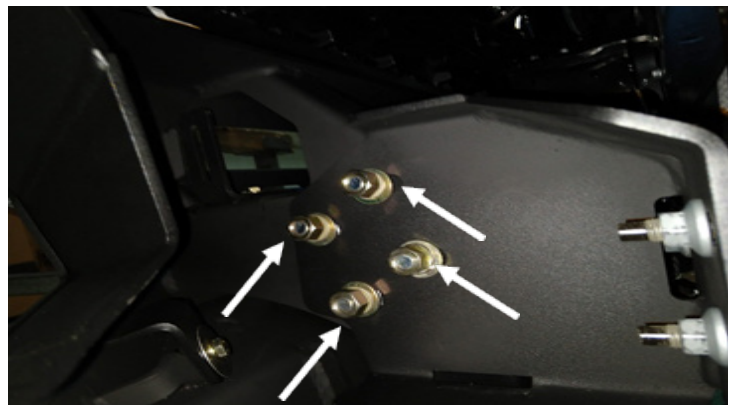

Figure 26

31. With assistance, adjust the bumper to the vehicle insuring at least a 1/4" gap between the top of the wings to the cut OEM bumper cover and 3/8" gap between the bumper and OEM grille. Then, center the bumper to the vehicle body left to right. (Figure 27)



Figure 27

32. Using a 3/4" socket wrench tighten the nuts installed in step 30.

33. Using a 17mm socket wrench, tighten the OEM hardware installed in step 27.

34. Bumper installation is now complete.

Maintenance/Care

- Periodically check and tighten all fasteners.
- Stripped, fractured, or bent bolts or nuts need to be replaced.