

LoadLifter 7500 XL™

ULTIMATE



XL

ULTIMATE



Installation Guide

Kit 57595

Dodge/RAM Heavy Duty



Representative vehicle image

MN-1035 • (042011) • ECR 9273

For maximum effectiveness and safety, please read these instructions completely before proceeding with installation.

Failure to read these instructions can result in an incorrect installation.

LoadLifter 7500 XL™ ULTIMATE

Table of Contents

A. Introduction	2
Important Safety Notice	2
Notation Explanation	2
Maintenance and Use Guidelines	2
Limited Warranty and Return Policy	2
B. Installation Diagram	3
Hardware List	3
Tools List	3
C. Installing the LoadLifter 7500 XL Ultimate System	4
Important System Information	4
Removing the Jounce Bumper and Installing the Frame Bracket	4
Assembling the Air Spring	5
Installing the Assemblies	7
D. Installing the Air Lines	12
Installing Nylon Air Lines	12
Installing the Heat Shield	12
E. Finished Installation Photos	13
Installation Checklist	13

A. Introduction

The purpose of this publication is to assist with the installation and maintenance of the LoadLifter 7500 XL Ultimate air spring kits. All LoadLifter 7500 XL Ultimate kits utilize sturdy, reinforced, commercial-grade single or double, depending on the kit, convolute bellows.

The air springs are manufactured like a tire with layers of rubber and cords that control growth. LoadLifter 7500 XL Ultimate kits provide up to 7,500 pounds (3,400kg) of load-leveling support with air adjustability from 5-100 PSI (.34-7BAR).

It is important to read and understand the entire installation guide before beginning installation or performing any maintenance, service or repair.

NOTATION EXPLANATION

Hazard notations appear in various locations in this publication. Information which is highlighted by one of these notations must be observed to help minimize risk of personal injury or possible improper installation which may render the vehicle unsafe. Notes are used to help emphasize areas of procedural importance and provide helpful suggestions. The following definitions explain the use of these notations as they appear throughout this guide.

DANGER

INDICATES IMMEDIATE HAZARDS WHICH WILL RESULT IN SEVERE PERSONAL INJURY OR DEATH.

CAUTION

INDICATES HAZARDS OR UNSAFE PRACTICES WHICH COULD RESULT IN SEVERE PERSONAL INJURY OR DEATH.

WARNING

INDICATES HAZARDS OR UNSAFE PRACTICES WHICH COULD RESULT IN DAMAGE TO THE MACHINE OR MINOR PERSONAL INJURY.

MAINTENANCE AND USE GUIDELINES

Minimum Recommended Pressure	Maximum Air Pressure
5 PSI (.34BAR)	100 PSI (7BAR)

1. Check air pressure weekly.
2. Always maintain normal ride height. Never inflate beyond 100 PSI (7BAR).
3. If the system develops an air leak, use a soapy water solution to check all air line connections and the inflation valve core before deflating and removing the air spring.

CAUTION

FOR SAFETY AND TO PREVENT POSSIBLE DAMAGE TO THE VEHICLE, DO NOT EXCEED MAXIMUM GROSS VEHICLE WEIGHT RATING (GVWR) OR PAYLOAD RATING, AS INDICATED BY THE VEHICLE MANUFACTURER.

CAUTION

ALTHOUGH THE AIR SPRINGS ARE RATED AT A MAXIMUM INFLATION PRESSURE OF 100 PSI (7BAR), THE AIR PRESSURE ACTUALLY NEEDED IS DEPENDENT ON LOAD AND GROSS VEHICLE WEIGHT RATING.

B. Installation Diagram

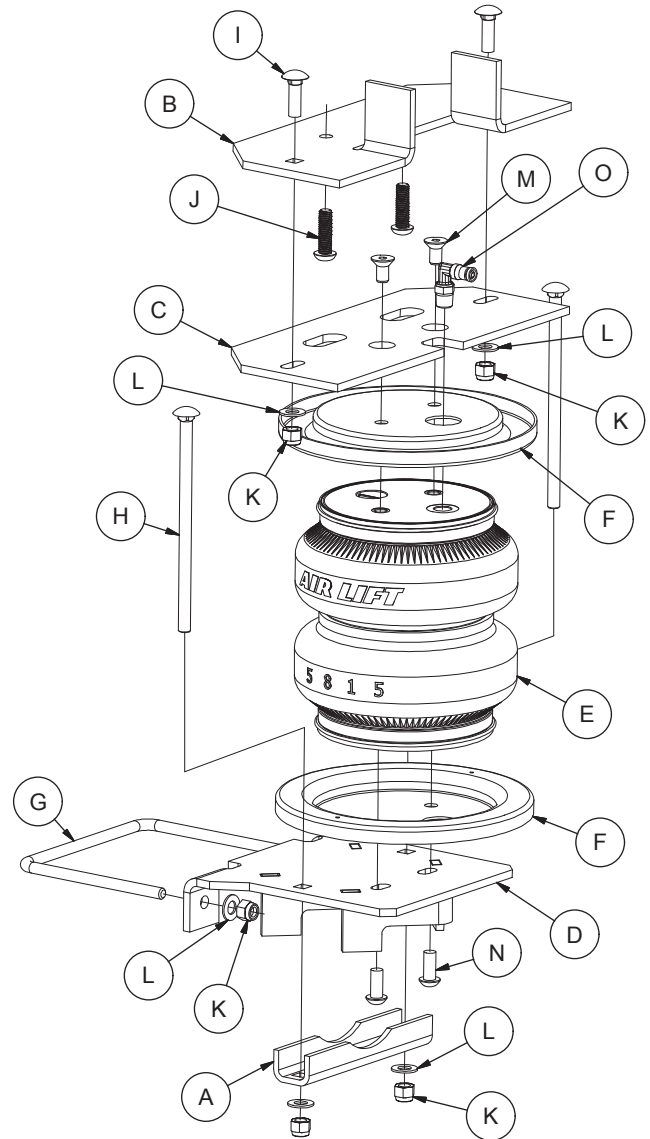
HARDWARE LIST

Item	Part #	Description	Qty
A	01531	Clamp bar	2
B	07407	Upper bracket, frame.....	2
C	07409	Upper bracket, air spring	2
D	03015	Lower bracket	2
E	58120	Air spring	2
F	11897	Roll plate	4
G	11717	U-bolt	2
H	17163	3/8"-16 x 7" Carriage bolt.....	4
I	17361	3/8"-16 x 1 1/4" Carriage bolt.....	4
J	17366	M10-1.5 x 35 Button-head cap screw... 4	4
K	18435	3/8"-16 Nylon lock nut.....	12
L	18444	3/8" Flat washer.....	12
M	17215	3/8"-24 x 7/8" Flat-head cap screw..... 4	4
N	17527	3/8"-24 x 3/4" Button-head cap screw.. 4	4
O	21837	90 degree Swivel elbow fitting.....	2
AA*	20086	Air line assembly	1
BB*	10466	Zip tie	6
CC*	21230	Valve cap.....	2
DD*	18501	5/16" Flat washer	2
EE*	21234	Rubber flat washer.....	2
FF*	18411	Small star washer.....	2
GG*	21233	5/16" Hex nut.....	4

*Not shown in diagram

TOOLS LIST

Description.....	Qty
Metric & STD open-end box wrenches	set
Ratchet with metric and STD sockets.....	set
Drill and 5/16" drill bit.....	1
Torque wrench.....	1
Hex key wrenches metric and STD.....	set
Hose cutter, razor blade or sharp knife	1
Bench or hand grinder.....	1
Hoist or floor jack	1
Safety stands.....	2
Safety glasses	1
Air compressor or compressed air source	1
Spray bottle with dish soap/water solution	1
Black spray paint.....	1



C. Installing the LoadLifter 7500 XL Ultimate System

IMPORTANT SYSTEM INFORMATION

The air springs will last much longer if they are not the suspension limiter in either compression or extension. The air spring compresses to 3.3" (84mm) and extends to 9.0" (229mm). Regardless of the load, the air pressure should be adjusted so that the normal ride height is maintained at all times. The shock absorber is usually the limiter on extension. If this is not the case, the use of limiting straps should be considered, particularly for off-road vehicles.

The vehicle may be equipped with a rear brake proportioning valve. Any type of load assist product could affect braking performance. Air Lift recommends that you check with your dealer before installing this type of product. If your vehicle DOES NOT have a rear brake proportioning valve or is equipped with an anti-lock type brake system, installation of a load assist product will have NO EFFECT on braking system performance.

CAUTION

COMPRESSED AIR CAN CAUSE INJURY AND DAMAGE TO THE VEHICLE AND PARTS IF IT IS NOT HANDLED PROPERLY. FOR YOUR SAFETY, DO NOT TRY TO INFLATE THE AIR SPRINGS UNTIL THEY HAVE BEEN PROPERLY SECURED TO THE VEHICLE.

REMOVING THE JOUNCE BUMPER AND INSTALLING THE FRAME BRACKET

1. Raise the vehicle and support it in a way, using safety stands or equivalent, that the axle can be safely dropped away from the frame. This will need to be done in order for the air spring assemblies to be put into position between the axle and frame (Fig. C.1).

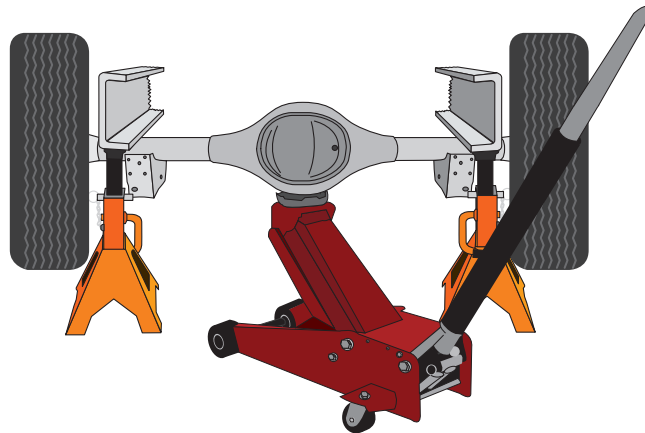


fig. C.1

2. Unbolt and remove the jounce bumper from the jounce bumper bracket that is welded to the frame (Fig. C.2). Figure C.3 shows the jounce bumper removed.

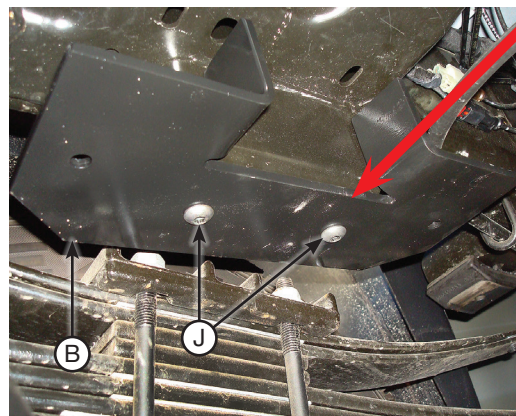


fig. C.2



fig. C.3

3. Install the upper frame brackets (B) on both sides of the frame with two M10-1.5 x 35 button head cap screws (J) making sure the cutout in the brackets face inboard, away from the tire (Fig. C.4). Torque the hardware to 37 lb.-ft. (50Nm).



Cutout goes inboard on both sides of the truck.

fig. C.4

ASSEMBLING THE AIR SPRING

1. Set a roll plate (F) on top of the air spring (E). The radiused, or rounded, edge of the roll plate will be toward the air spring so that it is seated inside the roll plate (Fig. C.5). Install the 90 degree swivel elbow fitting (O) into the top of the air spring, finger-tight plus 1 1/2 turns.



fig. C.5

2. Install the upper air spring brackets (C) onto the air spring assemblies with the 3/8"-24 x 7/8" flat-head cap screws (M) (Fig. C.6) and torque to no more than 20 lb.-ft. (27Nm).

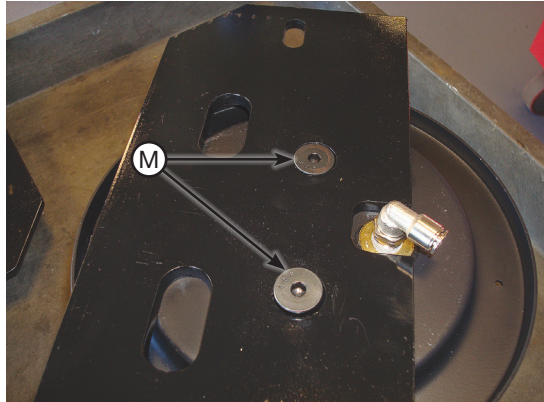


fig. C.6

3. Insert two 3/8"-16 x 7" carriage bolts (H) into the square holes of both lower brackets (D) (Fig. C.7).

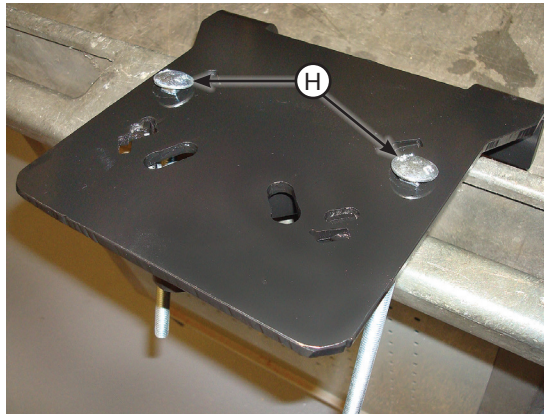
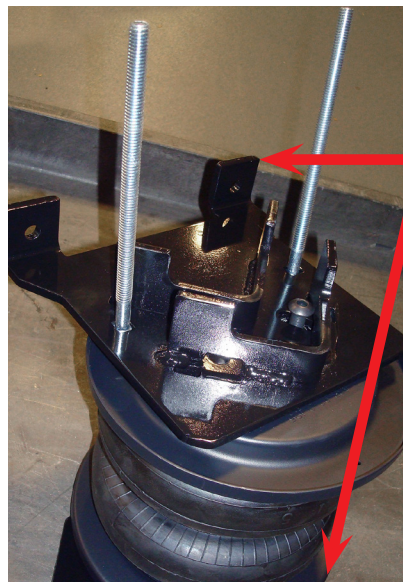


fig. C.7

4. Set a roll plate over the bottom of the air spring. Set the lower bracket with the carriage bolts installed, onto the air spring assembly so that the long flanges of the lower bracket are on the opposite side of the fitting at the top of the assemblies (Fig. C.8).



The flanges on the lower bracket must be on the opposite side of the fitting that is on the top of the air spring assemblies.

fig. C.8

5. Insert one 3/8"-24 x 3/4" (N) button-head cap screw into one of the slots in the lower bracket and just start to thread it into the lower end cap (Fig. C.9). The leg of the lower bracket has a cutout in it for the head of the screw to fit into. Lift up the lower bracket to create a gap between it and the air spring end cap and position the head of the screw under the leg of the bracket. Insert another screw into the remaining slot, position it under the leg of the bracket like the other one and by using a 7/32" hex-head wrench, tighten both evenly until the lower bracket is tight to the air spring (C.10). Torque both to no more than 20 lb.-ft. (27Nm).

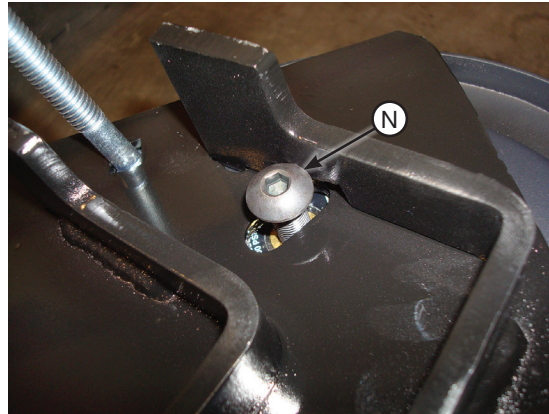


fig. C.9

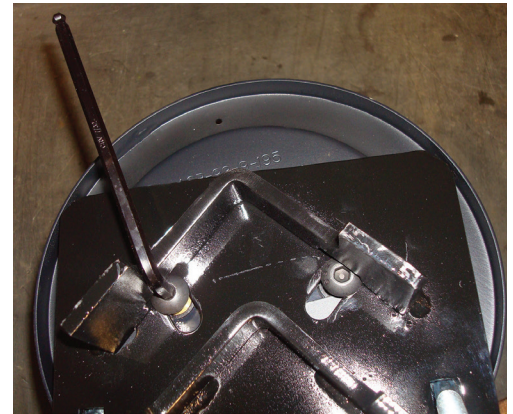


fig. C.10

NOTE

It may be necessary to hold the long carriage bolts in place while tightening these bolts.

6. Figure C.11 shows both assemblies ready for installation.



fig. C.11

INSTALLING THE ASSEMBLIES

1. Drop the axle down to make room for installing the assemblies.

NOTE

For the driver's (left) side installation, there are two different ways to set the assembly on the axle based on the early- and late-model brake line installation. Please read the next two steps and review the photos to distinguish what style brake line and the way of the installation that pertains to your model.

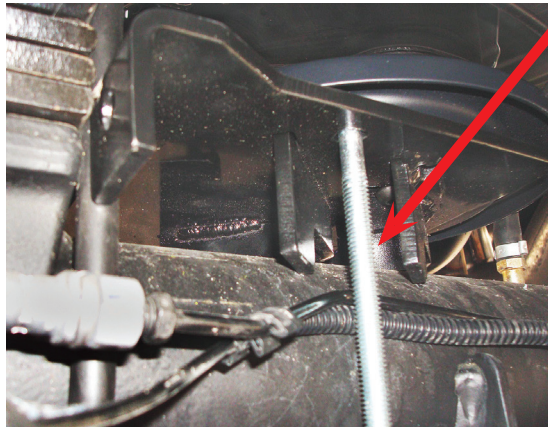
- For the early-model trucks that have the hard brake line that is behind the axle and that is mounted away from the axle (has a gap between the axle and brake line), as you are setting the driver's side assembly into position, make sure the lower bracket carriage bolt that will be behind the axle is in between the brake line and the axle (Fig. C.12).



Carriage bolt must be between the hard brake line and axle for this model that has the brake line routed off the axle.

fig. C.12

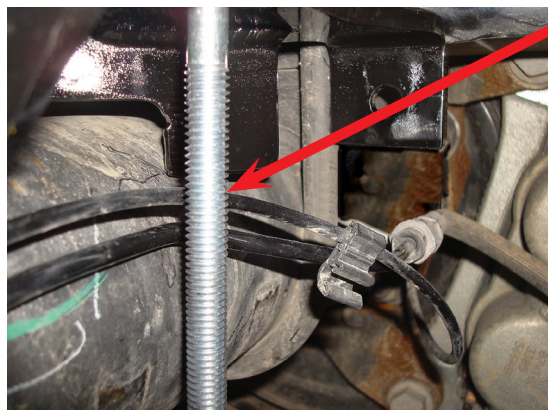
- For the late-model trucks that have the hard brake line and possibly an ABS harness that is behind and mounted flush to the axle (has no gap between the axle and brake line), set the driver's side assembly into place make sure the carriage bolt goes on the outside of the brake line (Fig. C.13).



Carriage bolt must be on the outside of the hard brake line and axle for this model that has the brake line flush to the axle.

fig. C.13

- On the passenger's (right) side, the lower bracket carriage bolt is always on the outside of the brake line on all early and late model trucks (Fig. C.14).



The carriage bolt is always on the outside of the brake line on the passenger's (right) side, regardless of the year.

fig. C.14

- On some models, the roll plate on the driver's (left) side may come in contact with the vent tube hose that comes out of the axle on the driver's (left) side. It may be necessary to modify the roll plate by cutting or grinding a small section out to clear the hose. The lower bracket must sit flush on the axle with no axle vent tube interference (Figs. C.15a & C.15b). Spray paint any exposed metal from grinding or cutting the roll plate before the final installation of the assembly.

It may be necessary to modify the lower roll plate if it contacts the vent tube on the driver's (left) side.



fig. C.15a

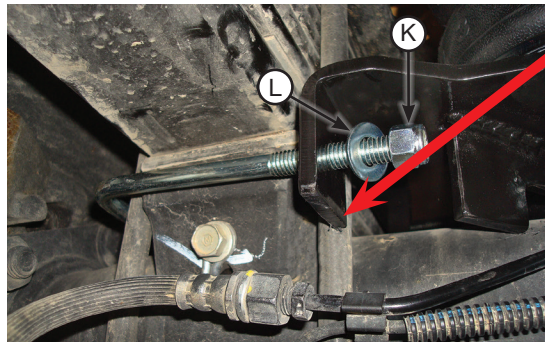


fig. C.15b

- Push the lower brackets up against the leaf spring pack so that the front and back legs are locked around the stock U-bolts. Set the U-bolt (G) supplied around the spring stack and through the legs of the lower bracket (Fig. C.16). Install the 3/8" flat washers (L) over the U-bolts and cap with the 3/8" nylon lock nuts (K). Draw the hardware (snug only, do not tighten yet) evenly, making sure that the lower bracket stays nested against the stock leaf spring pack and the legs are around the U-bolts.

NOTE

The lower bracket must be flush against the stock U-bolts.



Draw hardware evenly (snug only, do not tighten yet) making sure the lower bracket stays in position and locked around the U-bolts.

fig. C.16

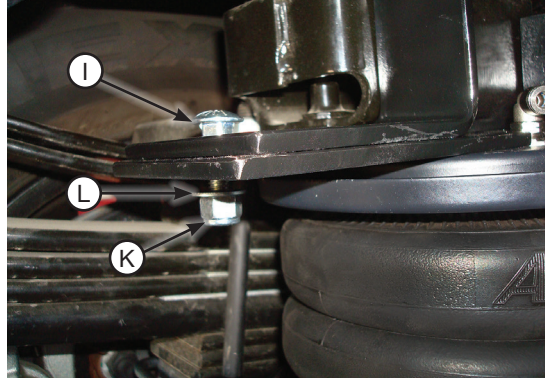
- Install the clamp bar (A) over the long lower bracket carriage bolts under the axle and cap with the 3/8" flat washers (L) and 3/8" nylon lock nuts (K) (Fig. C.17). Tighten the hardware evenly and torque to 16 lb.-ft. (22Nm).



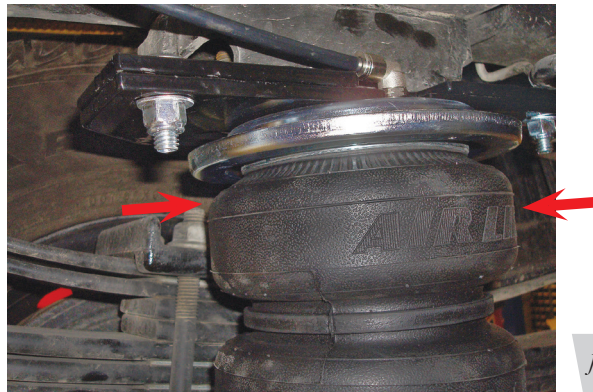
fig. C.17

- After torquing the lower clamp bar hardware, torque the leaf spring U-bolt that was previously installed and snugged to 10 lb.-ft. (14Nm).

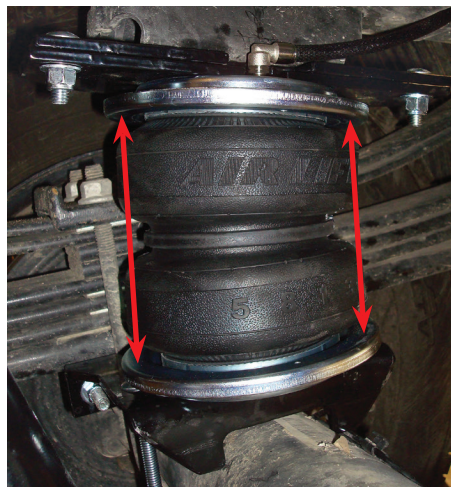
9. Raise the axle or lower the frame until the air spring and frame brackets just touch. Insert the 3/8"-16 x 1 1/4" carriage bolts (I) down through the top frame brackets as shown (Fig. C.18) and cap with 3/8" flat washers (L) and 3/8"-16 nylon lock nuts (K). Leave loose at this time.


fig. C.18

10. Raise the axle or lower the frame so that the safety stands can be removed. Using the slot in the upper bracket, push the top of the air spring forward or backward to align the air spring so that it is perpendicular (as much as possible) to both the upper and lower brackets. Torque the upper bracket hardware to 31 lb.-ft. (42Nm) (Fig. C.19).

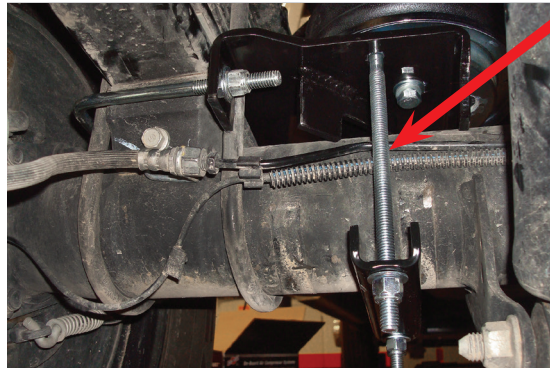

fig. C.19
NOTE

Once tight, the upper and lower brackets will not be parallel and may look like they are out of alignment. This condition is acceptable because of the way the lower bracket and upper bracket mounts are designed. Some variance from one unit to another is considered normal (Fig. C.20).


fig. C.20

 **CAUTION**

ONCE THE ASSEMBLIES ARE ADJUSTED AND TIGHT, MAKE SURE THE BRAKE LINES ON THE BACK (BOTH SIDES) DO NOT COME IN CONTACT WITH THE REAR CARRIAGE BOLTS. ADJUST BY PUSHING THE LINE OVER TO GAIN CLEARANCE IF NECESSARY (FIG. C.21).



Check driver's (left) and passenger's (right) sides to make sure the hard brake line is not rubbing on the carriage bolts. Adjust by pushing on the line to gain clearance if necessary.

fig. C.21

11. Make sure the emergency brake cable is above the upper brackets (Fig. C.22).

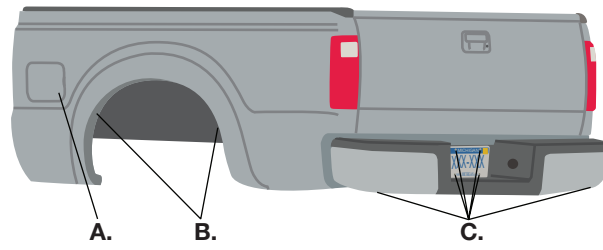


fig. C.22

D. Installing the Air Lines

Choose the locations for the Schrader valves and drill a 5/16" (8mm) hole, if necessary (Fig. D.1).

1. Cut the air line in half. Make clean, square cuts with a razor blade or hose cutter (Fig. D.2). Do not use scissors or wire cutters.



A. Inside fuel tank filler door
B. Inside rear wheel wells
C. License plate or rear bumper area

fig. D.1

CAUTION

KEEP AT LEAST 6" (152MM) OF CLEARANCE BETWEEN ALL AIR LINES AND THE EXHAUST SYSTEM. AVOID SHARP BENDS AND EDGES.

2. Use zip ties to secure the air line to fixed points along the chassis. Do not pinch or kink the air line. Leave at least 2" (51mm) of slack in the air line to allow for any movement that might pull on the air line. The minimum bend radius for the air line is 1" (25mm).
3. Install the Schrader valve in the chosen location (Fig. D.3).

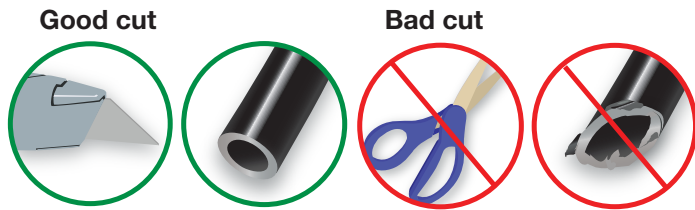


fig. D.2

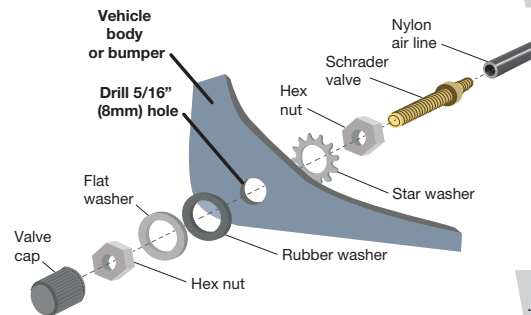


fig. D.3

INSTALLING THE HEAT SHIELD

1. Attach the metal heat shield to the exhaust where it is closest to the passenger's (right) side air spring. Slide the air line thermal sleeve over the air line and position it where the air line is closest to the exhaust. (Fig. D.4).

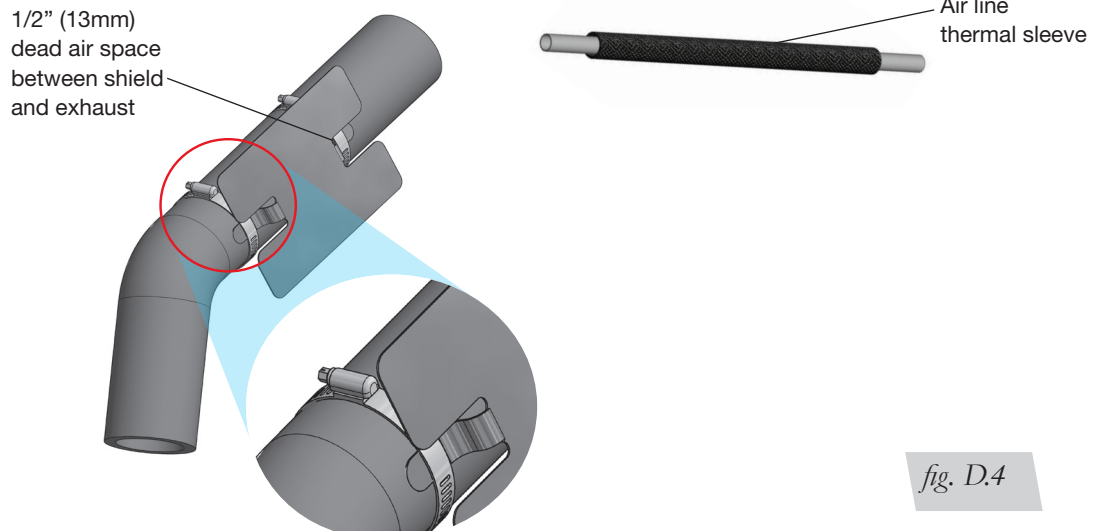


fig. D.4

E. Finished Installation Photos

1. The following images show the finished installation of both sides (Figs. E.1, E.2, E.3 & E.4).

Back view of the driver's (left) side installation.



fig. E.1

Inside view of the passenger's (right) side installation.

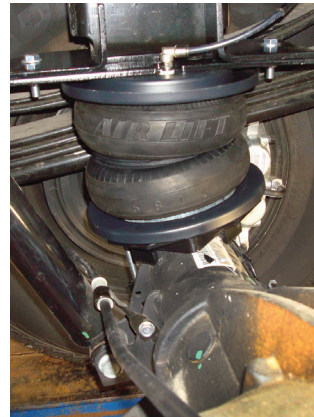


fig. E.2

Forward view of the driver's (left) side installation.

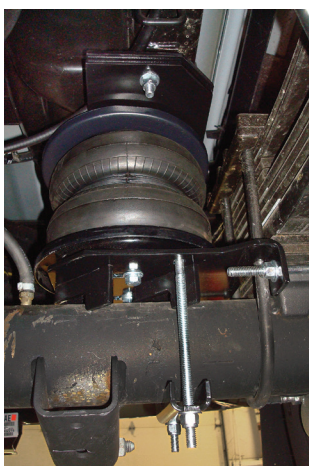


fig. E.3

Forward view of the passenger's (right) side installation.



fig. E.4

INSTALLATION CHECKLIST

- Clearance test** — Inflate the air springs to 40-60 PSI (2.8-4.1BAR) and make sure there is at least 1/2" (13mm) clearance from anything that might rub against each sleeve. Be sure to check the tire, brakes, frame, shock absorbers and brake cables.
- Leak test before road test** — Inflate the air springs to 40-60 PSI (2.8-4.1BAR) and check all connections for leaks. All leaks must be eliminated before the vehicle is road tested.
- Heat test** — Be sure there is sufficient clearance from heat sources, at least 6" (152mm) for air springs and air lines. If a heat shield was included in the kit, install it. If there is no heat shield, but one is required, call Air Lift customer service at **(800) 248-0892**.
- Fastener test** — Recheck all bolts for proper torque.
- Road test** — The vehicle should be road tested after the preceding tests. Inflate the springs to recommended driving pressures. Drive the vehicle 10 miles (16km) and recheck for clearance, loose fasteners and air leaks.
- Operating instructions** — If professionally installed, the installer should review the operating instructions with the owner. Be sure to provide the owner with all of the paperwork that came with the kit.