

LoadLifter 7500 XL™

ULTIMATE



Installation Guide



GM 2500-3500HD



Watch the video

Info on Table of Contents page

Kit 57541

For maximum effectiveness and safety, please read these instructions completely before proceeding with installation.

Failure to read these instructions can result in an incorrect installation.

TABLE OF CONTENTS

Installation Diagram	2
Hardware and Tools Lists	3
Introduction	4
Notation Explanation	4
Installing the System	5
Preparing the Vehicle	5
Assembling the Air Springs	7
Installing the Air Spring Assemblies	8
Installing the Air Lines	12
Finishing the Installation	13
Finished Installation Photos	14
Installation Checklist	15
Maintenance and Use Guidelines	15

Hardware and Tools Lists

HARDWARE LIST

Item	Part#	Description	Qty
A	01851	Clamp bar	2
B	03702	Lower bracket	2
C	07808	R.H. Upper bracket	1
D	07902	L.H. Upper bracket	1
E	11897	Roll Plate	4
F	58120	Air Spring	2
G	21837	90 degree Swivel air fitting	2
H	17215	3/8" - 24 X 3/4" Flat head socket cap screw	8
I	11323	3/8"-16 L-bolt	2
J*	11315	ABS wiring relocation bracket L.H. side	1
K*	11320	ABS wiring relocation bracket R. H. side	1
L	11771	3/8"-16 U-bolt (round end)	2
M	17142	3/8"-16 X 3 1/2" Carriage bolt	4
N*	17449	M8-1.25 X 10 Hex cap screw	2
O	18422	3/8"-16 Serrated flange lock nut	14
P*	18501	M8 Flat washer	2
Q*	20086	Air line	15ft
R*	10466	Zip ties	6
S*	21230	Valve cap	2
T*	21233	5/16" Hex nut	4
U*	21234	5/16" Rubber washer	2
V*	18411	Star washer	2
W	17586	3/8"-16 X 6 1/2" Hex cap screw	2
X	18444	3/8" Flat washer	2

* These parts are not shown in the Installation Diagram (Fig.1).

TOOLS LIST

Description	Qty
Standard and metric open-end or box wrenches	Set
Ratchet	1
Standard and metric, regular and deep-well sockets	Set
7/32" Hex-key wrench	1
5/16" Drill bits (very sharp)	1
Heavy duty drill	1
Torque wrench	1
Large screwdriver or small pry bar	1
Hose cutter, razor blade or sharp knife	1
Hoist or floor jack	1
Safety stands	1
Safety glasses	Pair
Air compressor or compressed air source	1
Spray bottle with dish soap/water solution	1

Introduction



The purpose of this publication is to assist with the installation and maintenance of the LoadLifter 7500 XL Ultimate air spring kit. LoadLifter 7500 XL Ultimate kits utilize sturdy, reinforced, commercial-grade double-convolute bellows.

The air springs are manufactured like a tire with layers of rubber and cords that control growth. LoadLifter 7500 XL Ultimate kits are recommended for most 3/4- and 1-ton pickups and SUVs with leaf springs and provide up to 7,500 pounds (3,402kg) of load-leveling support with air adjustability from 5-100 PSI (.34-7BAR).

It is important to read and understand the entire installation guide before beginning installation or performing any maintenance, service or repair.

NOTATION EXPLANATION

Hazard notations appear in various locations in this publication. Information which is highlighted by one of these notations must be observed to help minimize risk of personal injury or possible improper installation which may render the vehicle unsafe. Notes are used to help emphasize areas of procedural importance and provide helpful suggestions. The following definitions explain the use of these notations as they appear throughout this guide.

 DANGER	INDICATES IMMEDIATE HAZARDS WHICH WILL RESULT IN SEVERE PERSONAL INJURY OR DEATH.
 WARNING	INDICATES HAZARDS OR UNSAFE PRACTICES WHICH COULD RESULT IN SEVERE PERSONAL INJURY OR DEATH.
 CAUTION	INDICATES HAZARDS OR UNSAFE PRACTICES WHICH COULD RESULT IN DAMAGE TO THE MACHINE OR MINOR PERSONAL INJURY.

Installing the System

PREPARING THE VEHICLE

1. Raise the frame and support the frame with safety stands. Lower the axle as far as it can go (Fig. 2).

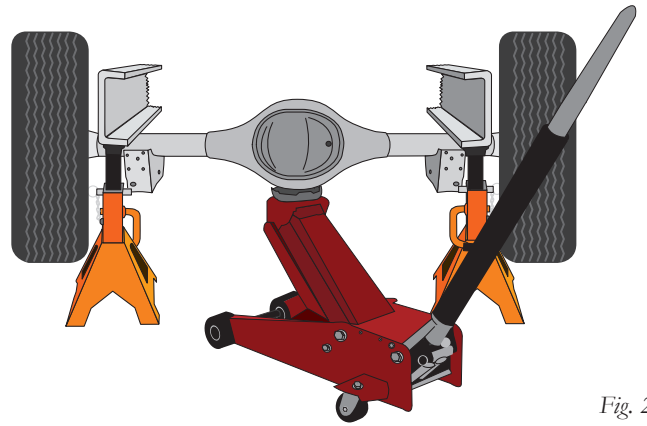

Fig. 2

2. Remove the jounce bumpers from the jounce bumper brackets on both sides by prying them out with a pry bar or large screwdriver (Fig. 3 & Fig. 4).

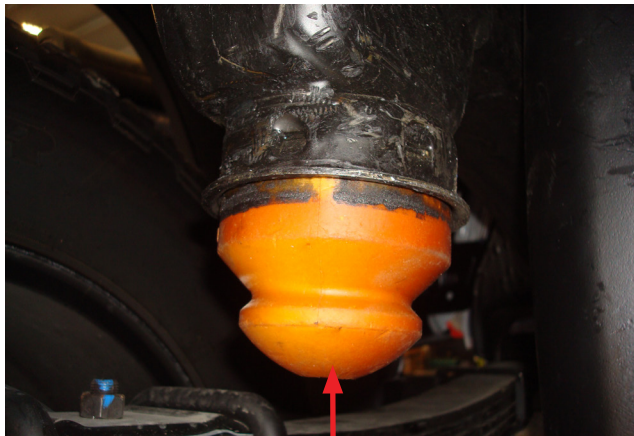

Fig. 3

Jounce bumper in
mounting cup



Fig. 4

Jounce bumper
removed

- Remove the two bolts that hold the brake/ABS line bracket onto the back side of the jounce bumper strike plate (Fig. 5 & Fig. 6). Pull the bracket away from the jounce bumper strike plate to make room for the lower bracket to be installed later.



Fig. 5

Remove bolt holding bracket



Fig. 6

Pull bracket away from jounce bumper strike plate

- Squeeze the two locking tabs on the large ABS wiring harness loom holder that is attached to the stock brake/ABS line bracket and pull out, disconnecting it from the bracket (Fig. 7 & Fig. 8). Detach the opposite side and leave loose for now.

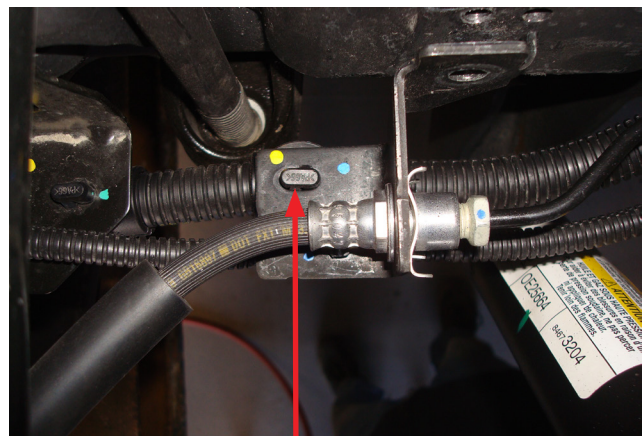

Fig. 7

Carefully remove from bracket

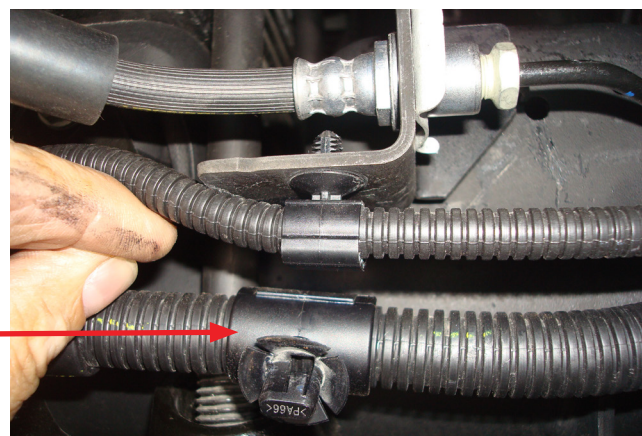

Fig. 8

Loom holder shown removed

ASSEMBLING THE AIR SPRINGS

1. Place the roll plates (E) on the air springs (F). Install the 90 degree swivel elbow fitting (G) onto the air springs (Fig. 9). Tighten the air fittings finger-tight plus 1 1/2 turns.

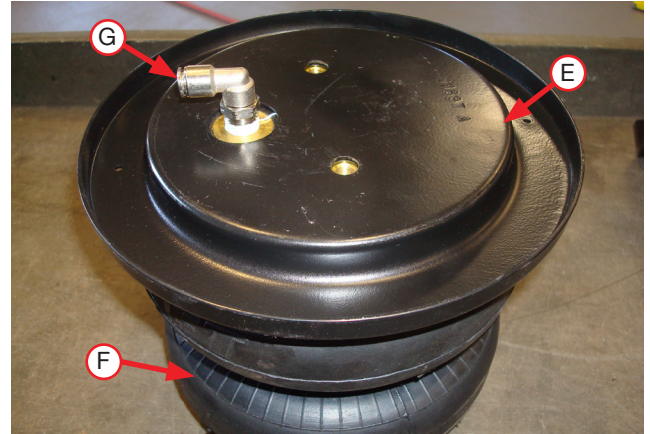

Fig. 9

2. Install both upper brackets (C & D) onto the air spring assemblies using the 3/8" flat head screws (H) (Fig. 10). Torque hardware to no more than 20 lb.-ft. (27Nm).
3. To determine which holes in the lower bracket (B) to use for installing on the air spring assemblies, set them next to each other with the angled sections pointing toward each other (Fig. 1, Fig. 11 & Fig. 12). Use the first and the third holes on each bracket to attach to the air springs. Set a roll plate (E) onto the air spring assembly and attach the lower bracket onto the air spring with two 3/8" flat head screws (H) and torque to no more than 20 lb.-ft (27Nm).

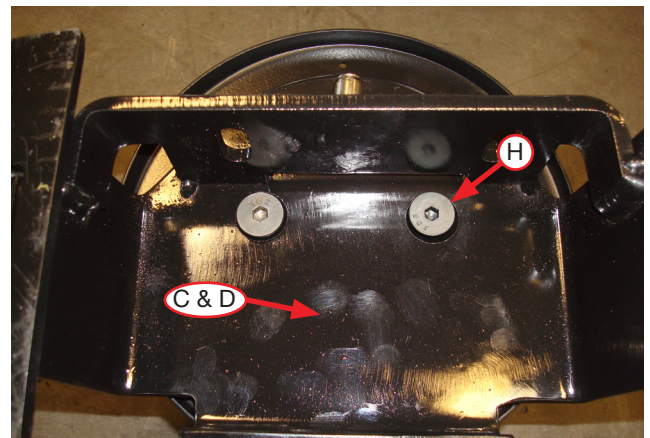

Fig. 10

NOTE

THE ANGLED SIDE OF THE LOWER BRACKET WILL BE ON THE FITTING SIDE OF THE AIR SPRING (FIGS. 1, 11 & 12).

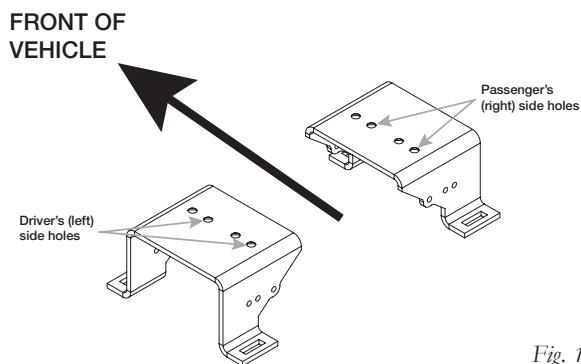

Fig. 11

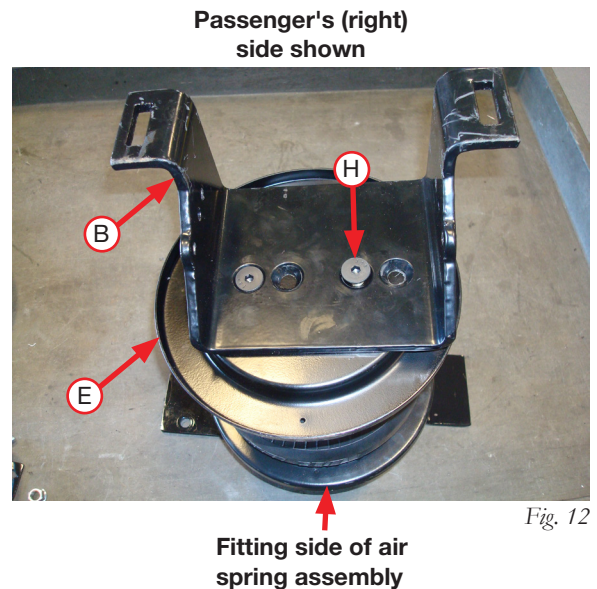

Fig. 12

4. Fig. 13 shows driver's (left) and passenger's (right) side assemblies.

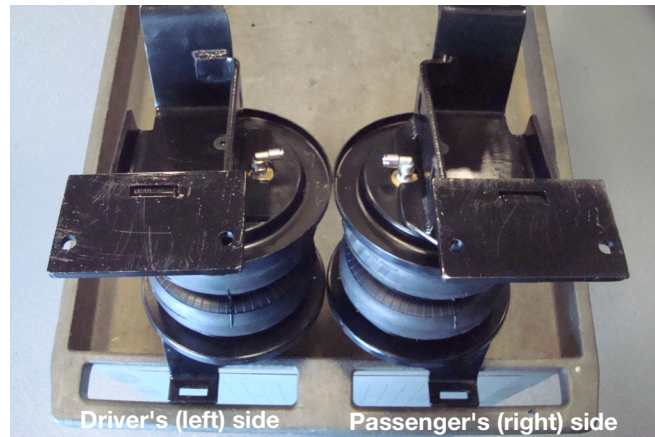

Fig. 13

INSTALLING THE AIR SPRING ASSEMBLIES

1. With the suspension at full extension, set the driver's (left-hand) and passenger's (right-hand) side assemblies over the axle jounce bumper strike plates making sure the fitting is pointing to the inside of the frame. Push the lower bracket down flush to the strike plate and by moving the air spring assembly in and out, align the lower bracket until the tab and the hole on the brake line/ABS bracket aligns with the holes in the lower bracket (Fig. 14).

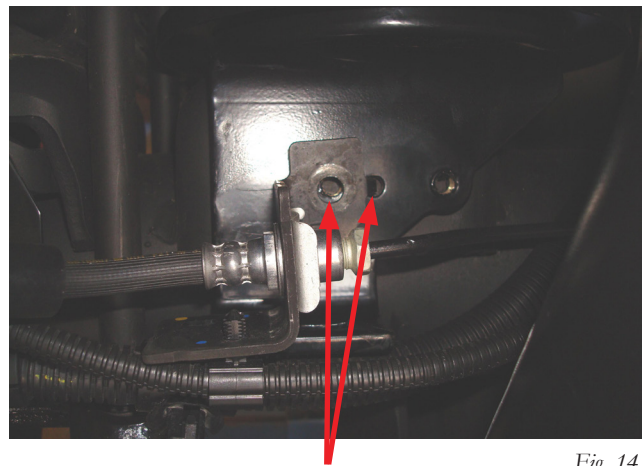

Fig. 14

Align brake/ABS bracket hole and tab with holes in the lower bracket

2. Attach the ABS loom holder (previously removed) to the underside of each ABS loom bracket (J & K) supplied (Fig. 15). The left-hand side is for the driver's (left) side, the right-hand side is for the passenger's (right) side. Once installed, the brackets will nest around the bottom of the lower bracket (Fig. 16).

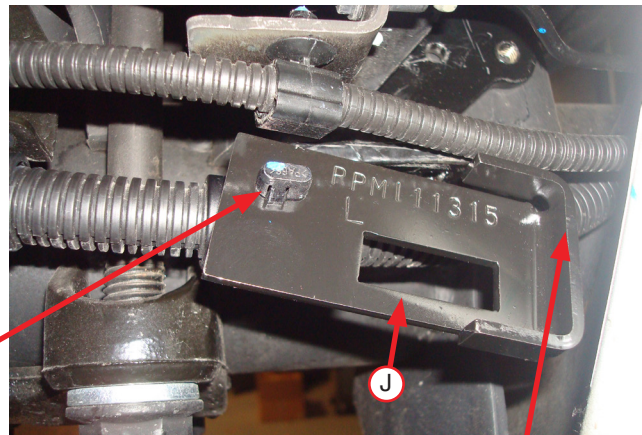

Fig. 15

Insert tab on ABS wire loom here

Tab on ABS bracket must be facing up and will nest around the lower bracket when installed

3. Insert a 3/8" carriage bolt (M) through the lower bracket and ABS loom holder previously installed (Fig. 16). Install a 3/8" serrated flange lock nut (O) onto the carriage bolt with the flat portion of the nut facing up. Tighten nut up enough to nest the ABS bracket around the lower bracket, but do not tighten yet. Repeat for both sides.

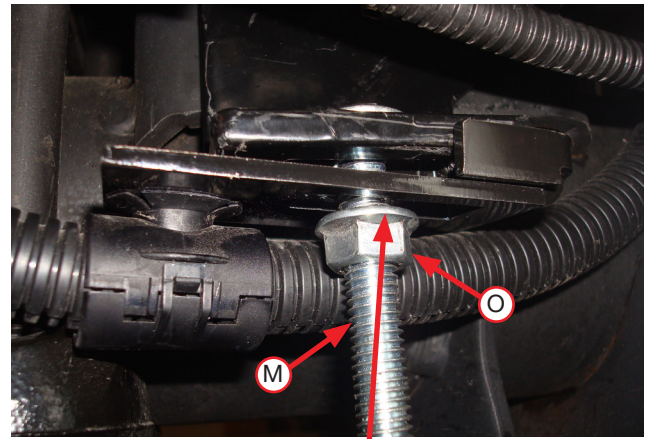

Fig. 16

Install nut with
flange facing up

NOTE

IF WIRE LOOM DOES NOT ALIGN CORRECTLY, UNCLIP LINE HOLDER, ADJUST, THEN RE-CLIP LINE HOLDER BACK ONTO LOOM.

4. Install the remaining 3/8" carriage bolts on the front side of the lower brackets and install the clamp bars (A) over the carriage bolts. Secure the clamp bar with the 3/8" serrated lock nuts (O) (Fig. 17). Align the clamp bar so that it is somewhat centered between the shock bracket and leaf spring retainer. Torque clamp bar hardware evenly to 16 lb.-ft. (22Nm). Repeat for both sides.

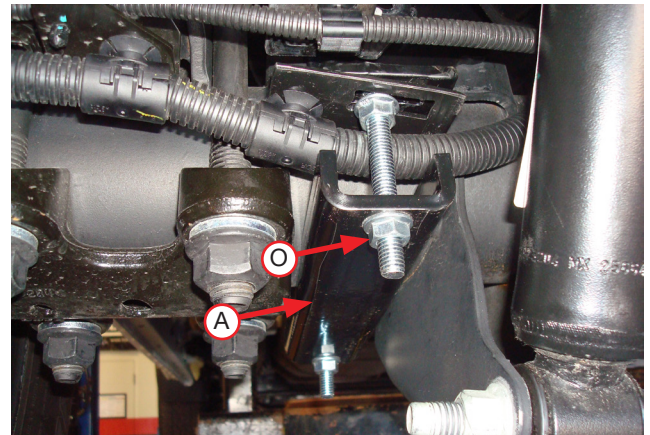

Fig. 17

5. Securely tighten the ABS bracket nut on both sides (Fig. 18).

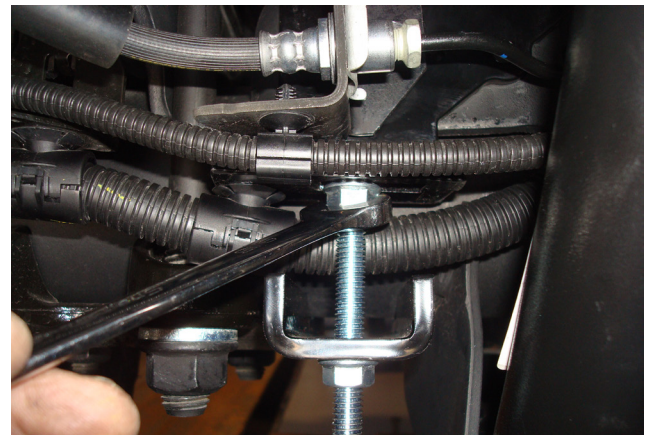
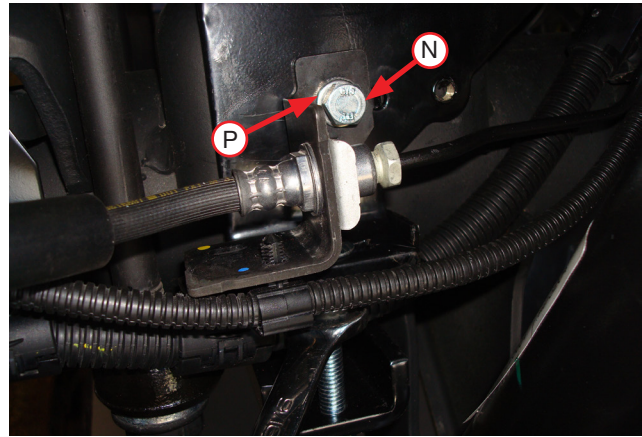
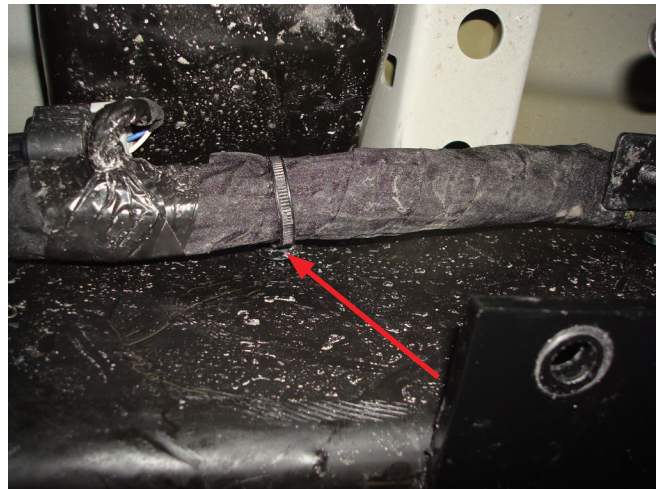

Fig. 18

6. Reattach the stock brake line/ABS brackets removed in the *Preparing the Vehicle* section using the M8 hex cap screws (N) and M8 flat washers (P) (Fig. 19). Tighten both sides securely.

Fig. 19

7. For the driver side only, pull the tree holder holding the wiring harness onto the frame, out of the frame (Fig. 20).

Fig. 20

8. Hold the L-bolt (I) parallel to the frame, insert the eye through the top of the frame from the inside out between the 5th wheel bracket and bed crossmember (Fig. 21).

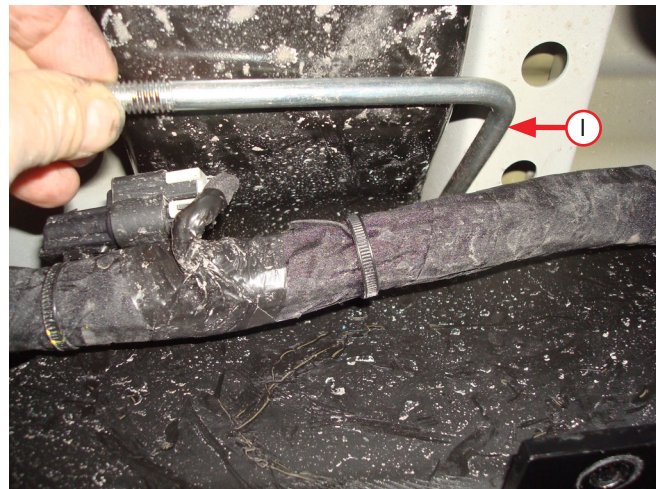
Fig. 21

9. When the eye is completely through the frame, rotate the L-bolt forward and under the wiring harness inside the frame (Fig. 22).



Fig. 22

10. Insert the 3/8" Hex cap screw (W) through a 3/8" flat washer (X), then all the way through the eye of the L-bolt (Fig. 23).

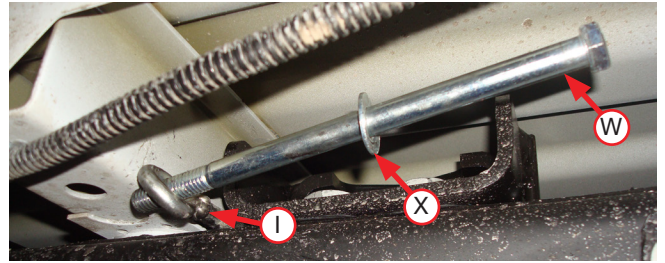

Fig. 23

11. Rotate the new "U-bolt" down and through the upper bracket holes, behind the axle. Install the 3/8" serrated flange lock nuts (O) onto the U-bolt (Fig. 24). Install the passenger's side U-bolt assembly and leave both sides loose at this time.



Fig. 24

12. Install the U-bolt (L) from the outside of the frame, over the jounce bumper mounting cup and through the upper bracket on the inside of the frame. Attach the U-bolt with the 3/8" serrated flange nuts (O) and leave loose at this time (Fig. 24 & Fig. 25).

NOTE

IT MAY BE NECESSARY TO TAP THE U-BOLT INTO POSITION BECAUSE OF THE WELDS AROUND THE JOUNCE BUMPER CUP.

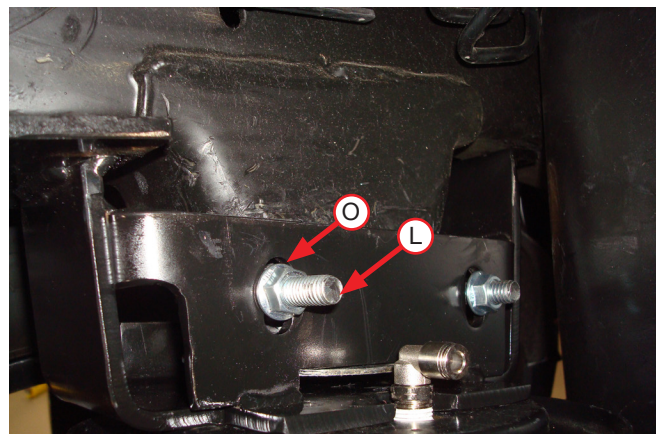

Fig. 25

Installing the Air Lines

Air lines are routed from the air springs to Schrader valves. LoadLifter 5000 series air lines come in two styles: nylon and braided stainless steel. Begin by choosing locations for the Schrader valves and drill a 5/16" (8mm) hole, if necessary (Fig. 26).

CAUTION

KEEP AT LEAST 6" (150MM) OF CLEARANCE BETWEEN ALL AIR LINES AND THE EXHAUST SYSTEM. AVOID SHARP BENDS AND EDGES.

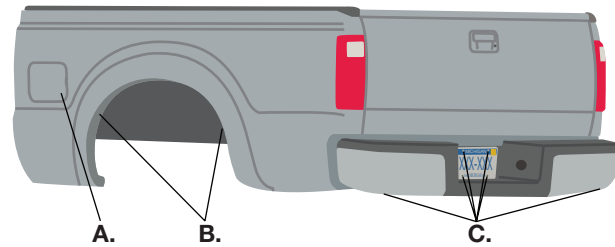

* For LoadLifter 5000 Ultimate Plus kits, the recommended location for the Schrader valves is the rear bumper area or license plate.

- A. Inside fuel tank filler door
- B. Inside rear wheel wells
- C. License plate or rear bumper area*

Fig. 26

INSTALLING NYLON AIR LINES

1. For nylon air line, it is recommended that the air line be routed along the top of the frame, forward of the axle, then down to the fitting (Fig. 27). After cutting the air line to length, install the air line thermal sleeve over the air line on the passenger's (right) side before inserting into the fitting. Secure the air lines to the upper coil spring mount with zip ties (BB) supplied.



Thermal sleeve

Fig. 27

2. Cut the air line in half. Make clean, square cuts with a razor blade or hose cutter (Fig. 28). Do not use scissors or wire cutters.

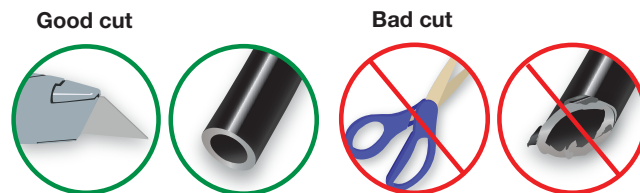

Fig. 28

3. Use zip ties to secure the air line to fixed points along the chassis. Do not pinch or kink the air line. The minimum bend radius for the air line is 1" (25mm). Leave at least 2" (50mm) of slack in the air line to allow for any movement that might pull on the air line.

4. Install the Schrader valve in the chosen location (Fig. 29).

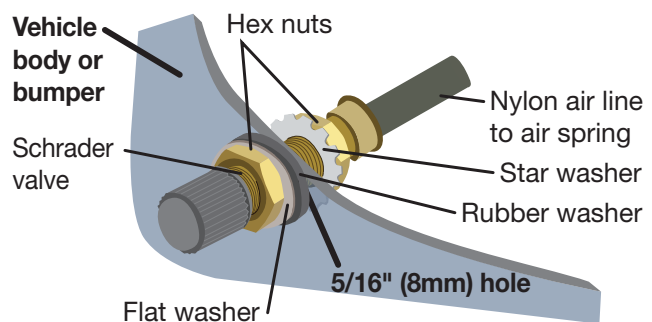

Fig. 29

FINISHING THE INSTALLATION

1. Once the hose is installed, inflate the system to 10 PSI and torque both upper bracket U-bolts to 10 lb.-ft. (14Nm) starting with the square U-bolt first.
2. Bend tabs to provide a dead air space between exhaust pipe and heat shield. (Fig. 30) Attach the heat shield to the exhaust pipe using the clamps. Bend the heat shield for maximum clearance to the air spring.
3. Fig. 31 shows heat shield installed.

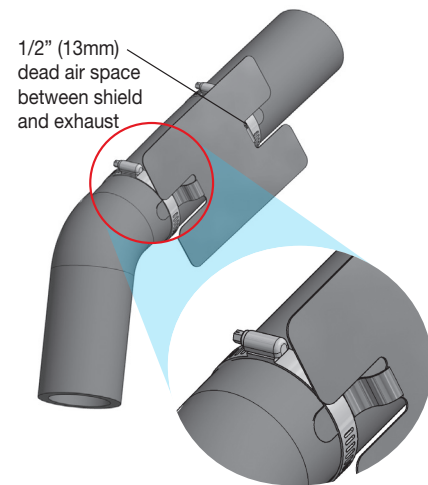

Fig. 30

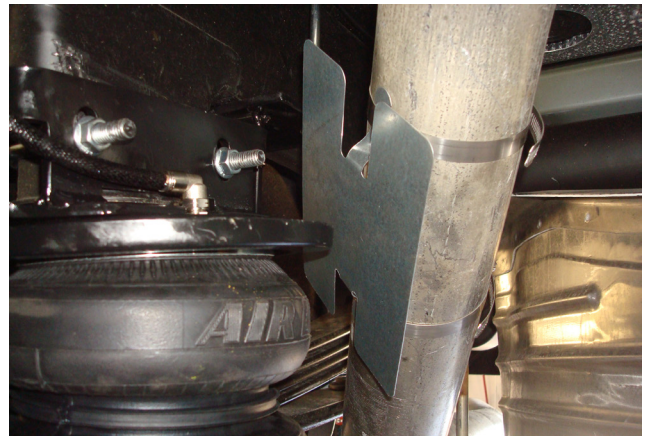
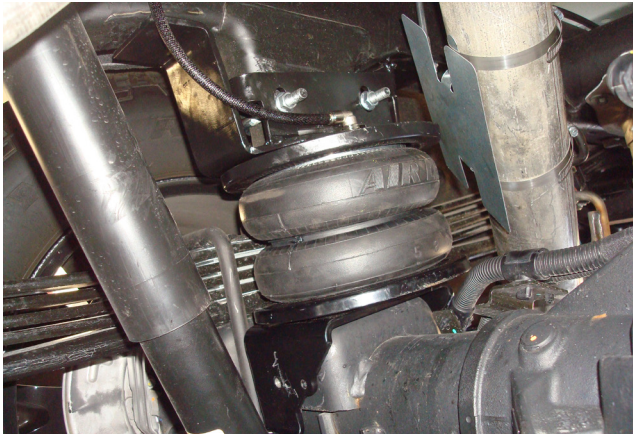

Fig. 31

FINISHED INSTALLATION PHOTOS

1. The following photos shows the finished installation of both sides (Fig. 32 - Fig. 35).



Inside, forward of axle view of driver's (left) side installation.

Fig. 32



Inside, forward of axle view of passenger's (right) side installation.

Fig. 33



Inside, rear of axle view of driver's (left) side installation.

Fig. 34



Inside, over axle view of passenger's (right) side installation.

Fig. 35

INSTALLATION CHECKLIST

- Clearance test** — Inflate the air springs to 40-60 PSI (2.8-4.1BAR) and make sure there is at least 1/2" (13mm) clearance from anything that might rub against each air spring. Be sure to check the tire, brakes, frame, shock absorbers and brake cables.
- Leak test before road test** — Inflate the air springs to 40-60 PSI (2.8-4.1BAR) and check all connections for leaks. All leaks must be eliminated before the vehicle is road tested.
- Heat test** — Be sure there is sufficient clearance from heat sources, at least 6" (152mm) for air springs and air lines. If a heat shield was included in the kit, install it. If there is no heat shield, but one is required, call Air Lift customer service at (800) 248-0892.
- Fastener test** — After 500 miles (800km), recheck all bolts for proper torque.
- Road test** — The vehicle should be road tested after the preceding tests. Inflate the air springs to recommended driving pressures. Drive the vehicle 10 miles (16km) and recheck for clearance, loose fasteners and air leaks.
- Operating instructions** — If professionally installed, the installer should review the operating instructions with the owner. Be sure to provide the owner with all of the paperwork that came with the kit.

MAINTENANCE AND USE GUIDELINES

1. Check air pressure weekly.
2. Always maintain normal ride height. Never inflate beyond 100 PSI (7BAR).
3. If the system develops an air leak, use a soapy water solution to check all air line connections and the inflation valve core before deflating and removing the air spring.

Minimum Recommended Pressure
5 PSI (.34BAR)

Maximum Air Pressure
100 PSI (7BAR)

CAUTION

FOR SAFETY AND TO PREVENT POSSIBLE DAMAGE TO THE VEHICLE, DO NOT EXCEED MAXIMUM GROSS VEHICLE WEIGHT RATING (GVWR) OR PAYLOAD RATING, AS INDICATED BY THE VEHICLE MANUFACTURER.

ALTHOUGH THE AIR SPRINGS ARE RATED AT A MAXIMUM INFLATION PRESSURE OF 100 PSI (7BAR), THE AIR PRESSURE ACTUALLY NEEDED IS DEPENDENT ON LOAD AND GROSS VEHICLE WEIGHT RATING.