

Load**LIFTER** 5000™ **ULTIMATE**

ADJUSTABLE AIR HELPER SPRINGS

TOW AND HAUL WITH SAFETY AND COMFORT™



Kit Number
88255

INSTALLATION GUIDE

For maximum effectiveness and safety, please read these instructions completely before proceeding with installation.

Failure to read these instructions can result in an incorrect installation.

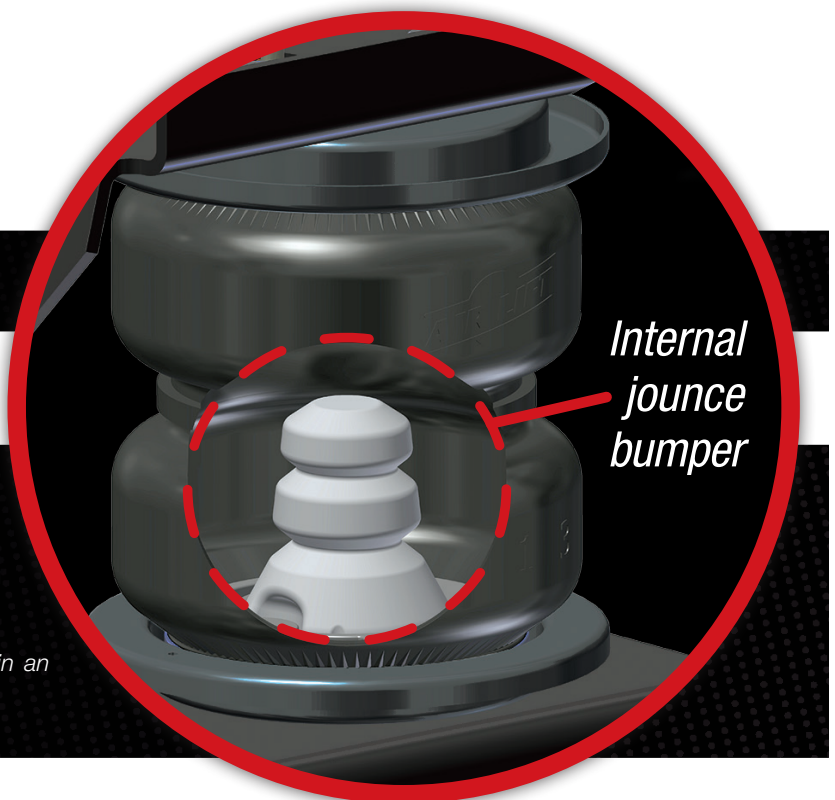

TABLE OF CONTENTS

Introduction	2
Important Safety Notice	2
Notation Explanation	2
Installation Diagram	3
Hardware List and Tools List	4
Hardware List	4
Tools List	4
Installing the LoadLifter 5000 Ultimate System	4
Getting Started	4
Assembling the Air Springs	6
Finished Assemblies	8
Attaching the Assemblies to the Frame	8
Installing the Air Lines	10
Tips for Installing Air Lines	11
Installing the Heat Shield	11
Finished Installation Photos	12
Before Operating	13
Checking for Leaks	13
Fixing Leaks	13
Installation Checklist	14
Post-Installation Checklist	14
Product Use, Maintenance and Servicing	15
Minimum and Maximum Pressure	15
Maintenance Guidelines	15
Tuning the Air Pressure	16
Guidelines for Adding Air	16
Troubleshooting Guide	17
Frequently Asked Questions	17

Introduction

The purpose of this publication is to assist with the installation, maintenance and troubleshooting of the LoadLifter 5000 Ultimate air spring kit. LoadLifter 5000 Ultimate utilizes sturdy, reinforced, commercial grade single or double, depending on the kit, convolute bellows. The bellows are manufactured like a tire with layers of rubber and cords that control growth. LoadLifter 5000 Ultimate kits are recommended for most 3/4- and 1-ton pickups and SUVs with leaf springs and provide up to 5,000 pounds of load-leveling support with air adjustability from 5-100 PSI.

It is important to read and understand the entire installation guide before beginning installation or performing any maintenance, service or repair. The information here includes a hardware list, tool list, step-by-step installation information, maintenance guidelines and operating tips.

Air Lift Company reserves the right to make changes and improvements to its products and publications at any time. For the latest version of this manual, contact Air Lift Company at **(800) 248-0892** or visit airliftcompany.com.

IMPORTANT SAFETY NOTICE

The installation of this kit does not alter the gross vehicle weight rating (GVWR) or payload of the vehicle. Check your vehicle's owner's manual and do not exceed the maximum load listed for your vehicle.

Gross vehicle weight rating: The maximum allowable weight of the fully loaded vehicle (including passengers and cargo). This number — along with other weight limits, as well as tire, rim size and inflation pressure data — is shown on the vehicle's Safety Compliance Certification Label.

Payload: The combined, maximum allowable weight of cargo and passengers that the truck is designed to carry. Payload is GVWR minus the base curb weight.

NOTATION EXPLANATION

Hazard notations appear in various locations in this publication. Information which is highlighted by one of these notations must be observed to help minimize risk of personal injury or possible improper installation which may render the vehicle unsafe. Notes are used to help emphasize areas of procedural importance and provide helpful suggestions. The following definitions explain the use of these notations as they appear throughout this guide.

INDICATES IMMEDIATE HAZARDS WHICH WILL RESULT IN SEVERE PERSONAL INJURY OR DEATH.



DANGER

INDICATES HAZARDS OR UNSAFE PRACTICES WHICH COULD RESULT IN SEVERE PERSONAL INJURY OR DEATH.



WARNING

INDICATES HAZARDS OR UNSAFE PRACTICES WHICH COULD RESULT IN DAMAGE TO THE MACHINE OR MINOR PERSONAL INJURY.



CAUTION

NOTE

Indicates a procedure, practice or hint which is important to highlight.

Installation Diagram

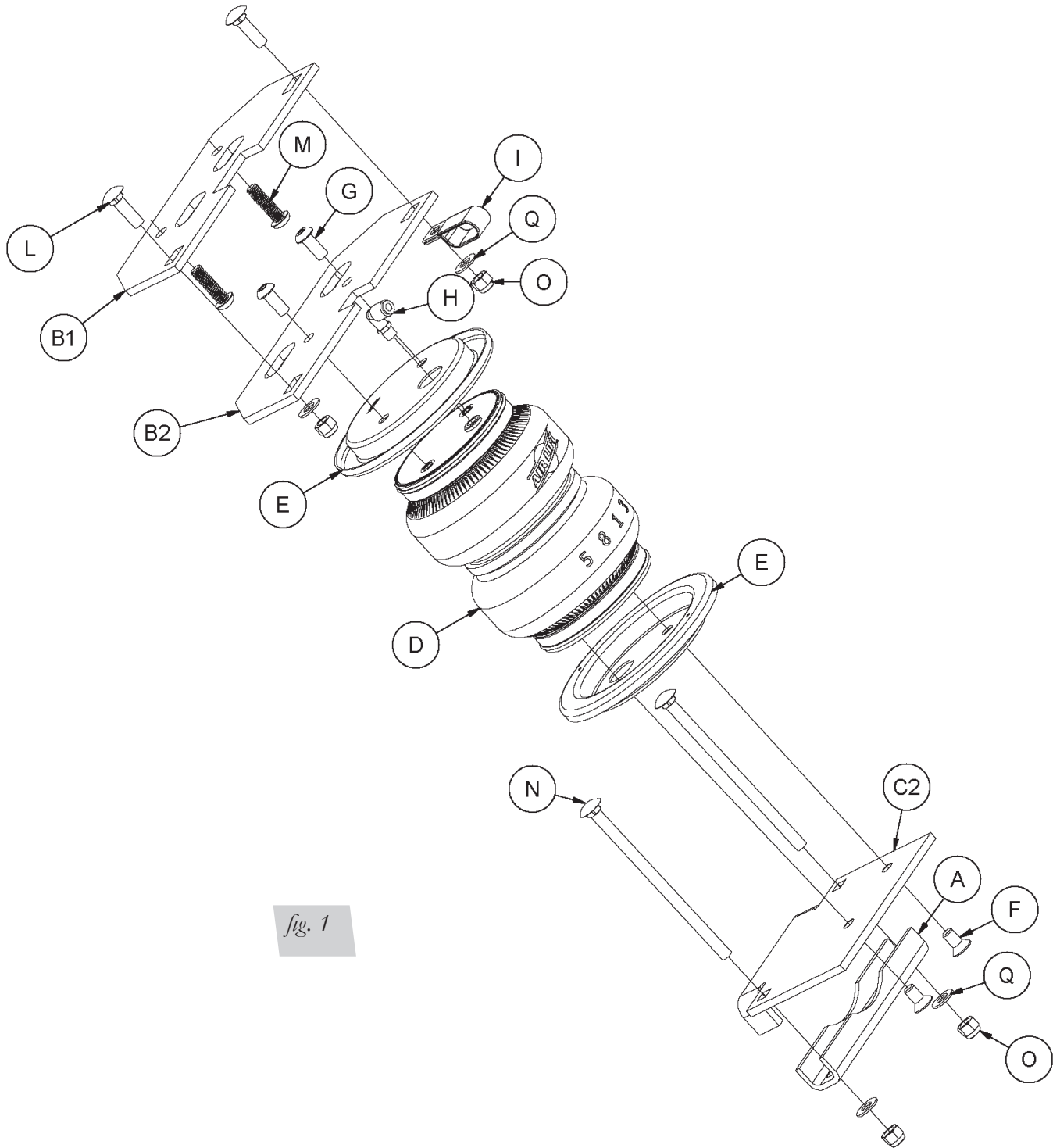

fig. 1

Hardware List and Tools List

HARDWARE LIST

Item	Part #	Description.....Qty	Item	Part #	Description.....Qty
A	01531	Clamp bar.....2	M	17366	M10-1.5 X 35 Button head screw.....4
B1	07149	Frame upper bracket.....2	N	17490	3/8"-16 X 6.5" Carriage bolts.....4
B2	07256	Bellows upper bracket.....2	O	18435	3/8" Nylon lock nuts.....8
C1	03018	Right hand lower bracket.....1	P	18438	5/16" Nylon lock nut.....1
C2	03033	Left hand lower bracket.....1	Q	18444	3/8" Flat washer.....8
D	58496	Bellows.....2	R	18501	5/16" Flat washer.....2
E	11967	Roll plates.....4	AA*	20086	Air line.....1
F	17215	3/8"-24 X 3/4" Flat head screws.....4	BB*	10466	Tie straps.....6
G	17365	3/8"-24 X 7/8" Button head screw.....4	CC*	21230	Valve cap.....2
H	21837	90° Swivel fitting.....2	DD*	18501	5/16" Flat washer.....2
I	10181	Frame clamp.....1	EE*	21234	Rubber washer.....2
J	11219	E-Brake adapter.....1	FF*	18411	Star washer.....2
K	17103	5/16"-18-1.25" Hex cap screw.....1	GG*	21233	5/16" Hex nut.....2

*Not shown in fig. 1

TOOLS LIST

Description..... Qty	Description..... Qty
9/16" crow's foot adapter..... 1	7/32 allen wrench (socket if available)..... 1
Standard open-end combo wrenches..... 1	Hose cutter, razor blade, or sharp knife 1
Ratchet..... 1	Hoist or floor jacks 1
5/16" drill bits (very sharp)..... 1	Safety stands..... 2
Metric and standard sockets..... 1	Safety glasses 1
Heavy duty drill..... 1	Air compressor or compressed air source 1
Torque wrench..... 1	Spray bottle with dish soap/water solution..... 1
#6 metric allen wrench (socket if available)..... 1	

Installing the LoadLifter 5000 Ultimate System

GETTING STARTED

1. Raise the vehicle and support the frame with jack stands. Drop the axle down to make room for the air spring assemblies to be put into position between the frame and axle (Fig. 2).



fig. 2

2. Unbolt and remove the left- and right-hand jounce bumpers (and spacers if equipped) (Fig. 3) from both frames above the axle.

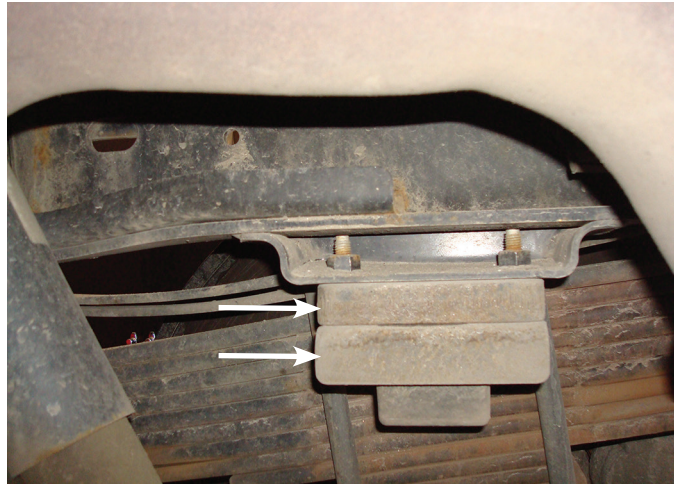

fig. 3

3. Using the stock jounce bumper holes, attach the frame upper brackets (B1) to the frame using the button head screws (M) (Figs. 1 & 4) on both sides, and torque mounting hardware to 30 lb.-ft.



fig. 4

4. On the right-side axle, above the shock, is an emergency brake line bracket (Fig. 5). Remove and retain the bolt holding the bracket to the axle.



fig. 5

- Attach the E-Brake adapter (J) to the axle using the stock bolt previously removed and tighten securely. Attach the stock E-Brake cable bracket to the adapter using one 5/16" cap screw (K) two flat washers (R) and one lock nut (P) (Fig. 6). Tighten securely.

fig. 6

ASSEMBLING THE AIR SPRINGS

- Set a roll plate (E) over the top of each air spring (D).

NOTE

The radiused (rounded) edge of the roll plate (E) will be towards the air spring so that the air spring is seated inside both roll plates.

- Install the swivel fitting (H) into the top of the air spring finger tight plus one-and-a-half turns (Fig. 7). Repeat for both air springs.

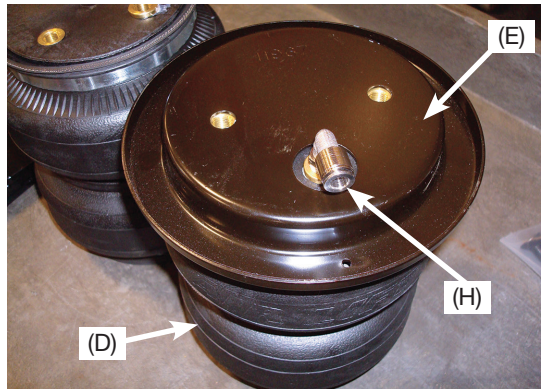
fig. 7

- Attach the bellows upper bracket (B2) to the air spring with two 3/8"-24 button head screws (G) and torque to no more than 20 lb.-ft. (Figs. 1 & 8). Repeat for the other air spring.

fig. 8

4. Flip over both air spring assemblies and set a roll plate over both ends.

NOTE

The radiused (rounded) edge of the roll plate (E) will be towards the air spring so that the air spring is seated inside both roll plates.

5. Insert the long 3/8" carriage bolt (N) into the lower bracket (C1 & C2) using the round hole which corresponds to the tapered hole (that is closest to the edge of the bracket) (Figs. 1 & 9) so that it points in the same direction as the flanges that come off the bracket.

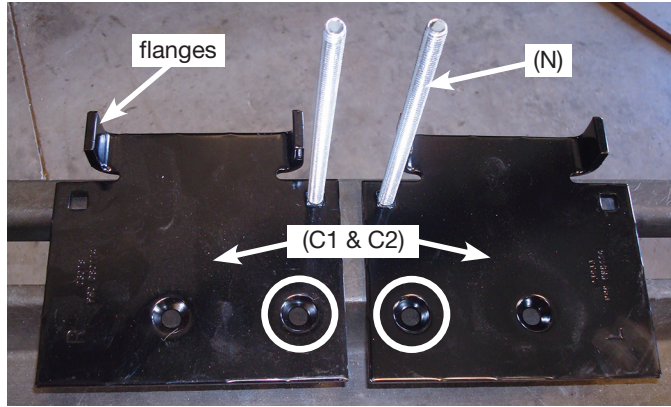

fig. 9

6. Attach the lower brackets with the carriage bolt and flanges mounted on the opposite side of the fitting, using the 3/8"-24 flat head screws (F) to the air spring assembly (Figs. 1 & 10). Torque to no more than 20 lb.-ft.

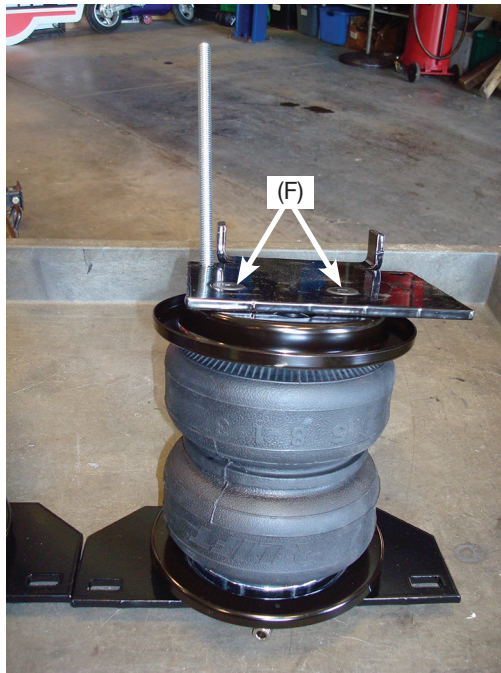

fig. 10

FINISHED ASSEMBLIES

*Right
(passenger) side
assembly*



*Left
(driver) side
assembly*

fig. 11

ATTACHING THE ASSEMBLIES TO THE FRAME

1. With the axle still suspended, set the left side assembly into position above the axle and insert one long 3/8" carriage bolt (N) into the remaining hole in the lower bracket (Fig. 12). Repeat for the right hand side.

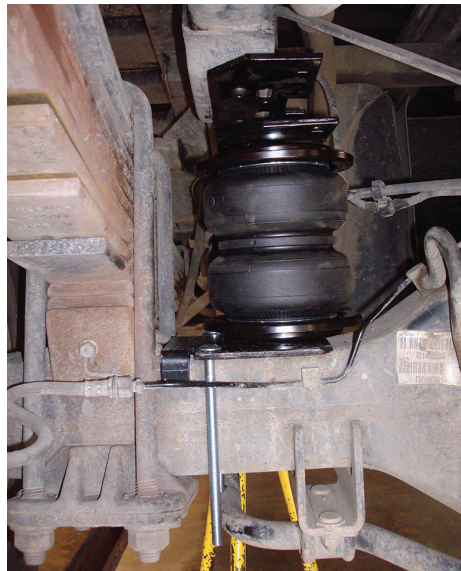
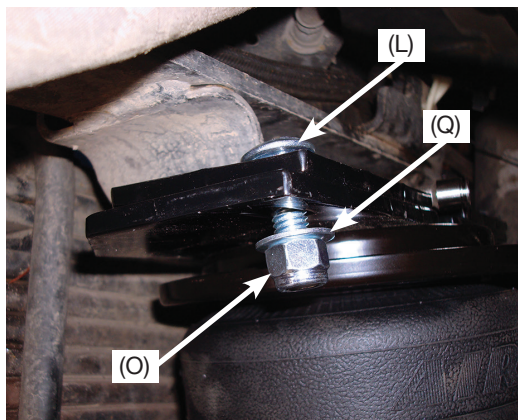

fig. 12

2. Raise the axle back up so the slots in the upper brackets line up with one another. Insert two short 3/8" carriage bolts (L) through the slots in the upper bellows and frame brackets (Figs. 1 & 13) from the top down.



*Back side of left
assembly shown*

fig. 13

3. Insert the frame clamp (I) onto the emergency brake cable (Fig. 14) and attach the frame clamp to the front upper bracket bolt of the driver side only. Cap the carriage bolts with two 3/8" flat washers (Q) and nylon lock nuts (O).

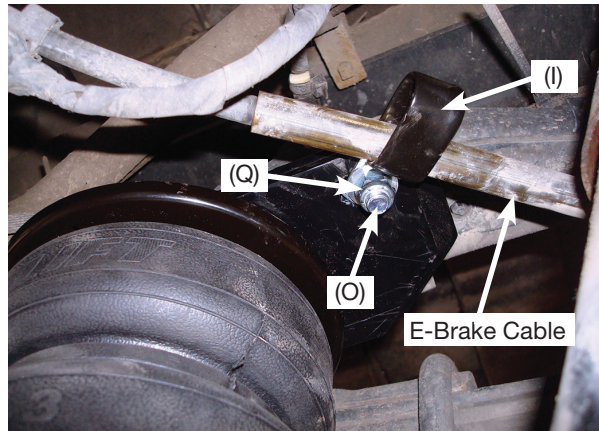

Front side of left assembly shown

fig. 14

4. Align the bellows so it is perpendicular to the upper and lower brackets. Torque the hardware to 16 lb.-ft.
5. Push the lower bracket against the axle/spring retainer (Fig. 15).

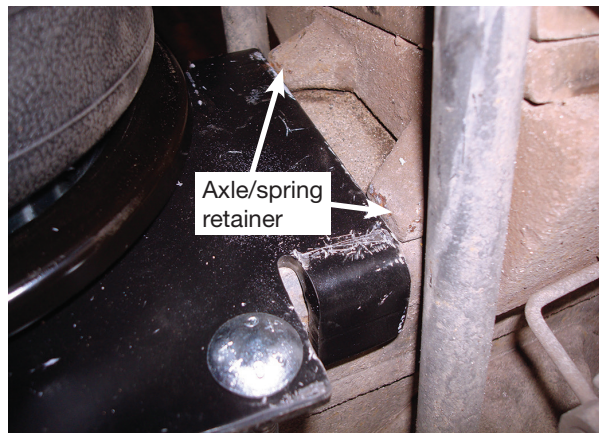

fig. 15

6. Insert the lower clamp bar (A) over the carriage bolts under the axle and cap with flat washers (Q) and nylon lock nuts (O). Repeat for the other side and torque all the lower mounting hardware evenly to 10 lb.-ft. (Fig. 16).

NOTE

It may be necessary to use a 9/16" crowfoot wrench on the forward carriage bolt because of the sway bar interference under the carriage bolt.

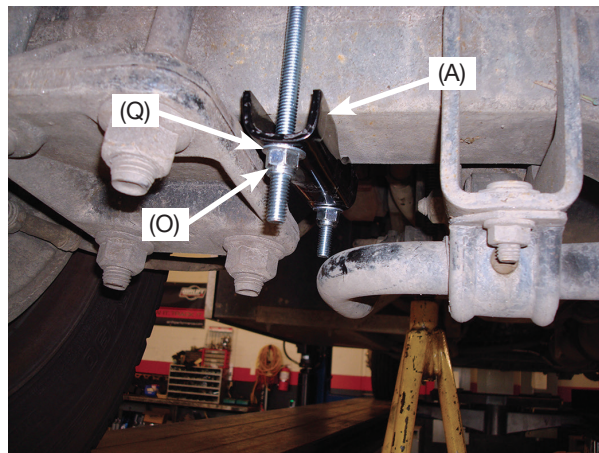
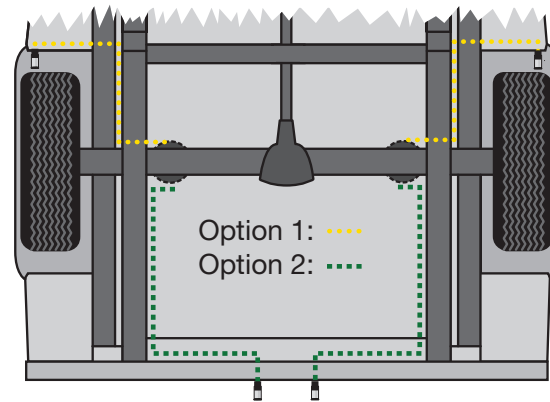

fig. 16

Installing the Air Lines

This section explains how to set up the air spring kit to be controlled with Schrader valves and a separate compressed air source. An on-board air compressor system allows for hassle-free control of the air springs. Learn more about Air Lift control systems at www.airliftcompany.com/products/compressor-systems.

1. Choose a convenient location for mounting the inflation valves (Fig. 17). Popular locations for the inflation valve are:
 - a. The wheel well flanges
 - b. The license plate recess in bumper
 - c. Under the gas cap access door
 - d. Through the license plate

fig. 17

NOTE

Whatever the chosen location, make sure there is enough clearance around the inflation valves for an air chuck.

2. Drill 5/16" holes to install the inflation valves.
3. Cut the air line assembly in two equal lengths.
4. Place a 5/16" nut and star washer on the air valve. Leave enough of the inflation valve in front of the nut to extend through the hole and have room for the rubber washer, flat washer, and 5/16" nut and cap. There should be enough valve exposed after installation – approximately 1/2" – to easily apply a pressure gauge or an air chuck (Fig. 18).

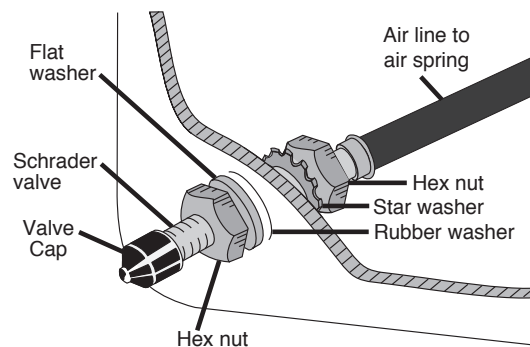
fig. 18

5. Push the inflation valve through the hole and use the rubber washer, flat washer, and another 5/16" nut to secure it in place. Tighten the nuts to secure the assembly.
6. Route the air line along the frame to the fitting on the air spring. Keep AT LEAST 6" of clearance between the air line and the exhaust system. Avoid sharp bends and edges. Use zip ties to secure the air line to fixed points along the chassis. Be sure that the tie straps are tight, but do not pinch the air line. Leave at least 2" of slack to allow for any movement that might pull on the air line.
7. Cut off the air line, leaving approximately 12" of extra air line. A clean square cut will prevent leaks. Insert the air line into the air fitting. This is a push-to-connect fitting.

TECH TIP

Wiggle the hose back and forth while inserting to make sure the hose bottoms out in the fitting to obtain a good seal.

TIPS FOR INSTALLING AIR LINES

When cutting air lines, use a sharp knife or a hose cutter and make clean, square cuts (Fig. 19). Do not use scissors or wire cutters because these tools may deform the air line, causing it to leak around fittings. Do not cut the lines at an angle.

Do not bend the 1/4" hose at a radius of less than 1" or bend the 3/8" hose at a radius of less than 1 1/2". Do not put side load pressure on fitting. The hose should be straight beyond the fitting for 1" before bending.

Inspect hose for scratches that run lengthwise on hose prior to installation. Contact Air Lift customer service at (800) 248-0892 if the air line is damaged.



To watch a video demonstrating proper air line cutting, go to air-lift.co/cuttingairline.

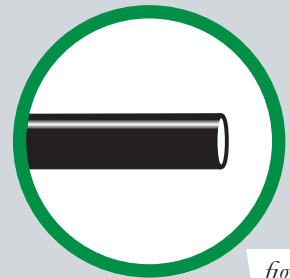
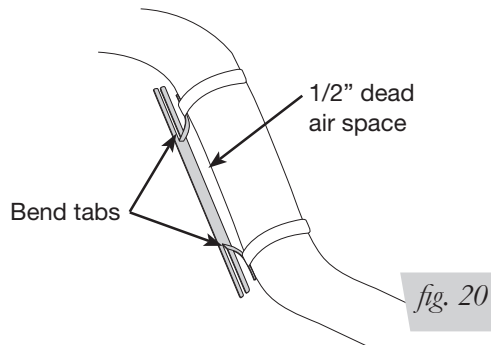

fig. 19



INSTALLING THE HEAT SHIELD

1. Bend tabs to provide a dead air space between exhaust pipe and heat shield. (Fig. 20) Attach the heat shield to the exhaust pipe using the clamps. Bend the heat shield for maximum clearance to the air spring.
2. The hose heat shield goes on the right side where the hose goes into the fitting on the bellows assembly (Fig. 21).



Add the hose heat shield to the right side before the fitting.



fig. 21

Finished Installation Photos

1. The following images show the finished installation of both sides (Figs. 22, 23, 24 & 25).

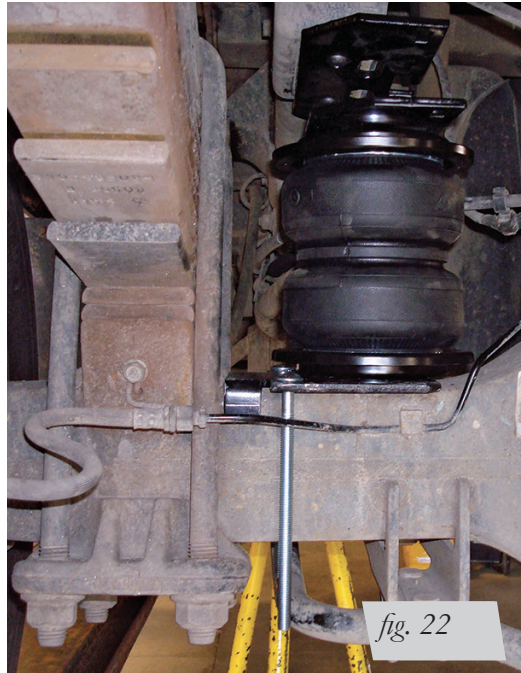

fig. 22

Figure 22 shows a rear view of the left (driver) side assembly.

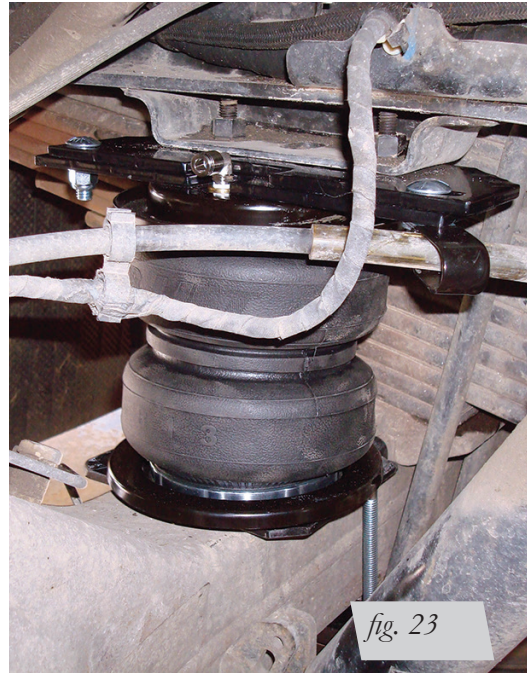

fig. 23

Figure 23 shows a front view of the left (driver) side assembly.

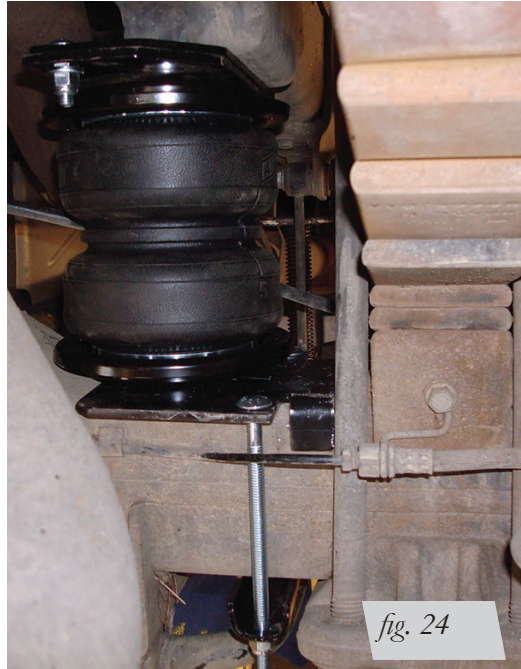

fig. 24

Figure 24 shows an inside rear view of the right (passenger) side assembly.

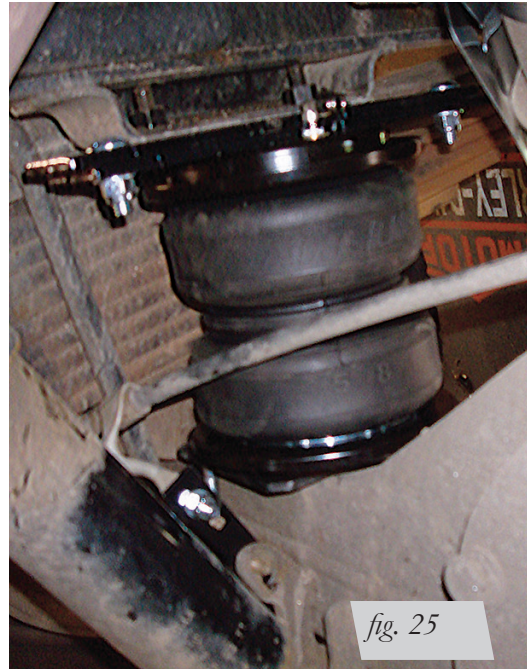

fig. 25

Figure 25 shows a front view of the right (passenger) side assembly.

Before Operating

CHECKING FOR LEAKS

1. Inflate the air spring to 30 PSI.
2. Spray all connections and the inflation valves with a solution of 1/5 liquid dish soap and 4/5 water. Spot leaks easily by looking for bubbles in the soapy water.
3. After the test, deflate the springs to the minimum pressure required to restore the system to normal ride height. Do not deflate to lower than 5 PSI.
4. Check the air pressure again after 24 hours. A 2-4 PSI loss after initial installation is normal. Retest for leaks if the loss is more than 5 PSI.

FIXING LEAKS

1. If there is a problem with the swivel fitting:
 - a. Check the air line connection by deflating the spring and removing the line by pulling the collar against the fitting and pulling firmly on the air line. Trim 1" off the end of the air line. Be sure the cut is clean and square (see Fig. 19). Reinsert the air line into the push-to-connect fitting.
 - b. Check the threaded connection by tightening the swivel fitting another half turn. If it still leaks, deflate the air spring, remove the fitting, and re-coat the threads with thread sealant. Reinstall by hand tightening as much as possible and then use a wrench for an additional two turns.
2. If there is a problem with the inflation valve:
 - a. Check the valve core by tightening it with a valve core tool.
 - b. Check the air line by removing the air line from the barbed type fitting. Cut the air line off a few inches in front of the fitting and use a pair of pliers or vice grips to pull/twist the air line off of the fitting.



CAUTION

DO NOT CUT OFF THE AIR LINE COMPLETELY AS THIS WILL USUALLY NICK THE BARB AND RENDER THE FITTING USELESS.

INSTALLATION CHECKLIST

- Clearance test** — Inflate the air springs to 75-90 PSI and make sure there is at least 1/2" clearance from anything that might rub against each sleeve. Be sure to check the tire, brakes, frame, shock absorbers and brake cables.

- Leak test before road test** — Inflate the air springs to 75-90 PSI and check all connections for leaks. All leaks must be eliminated before the vehicle is road tested.

- Heat test** — Be sure there is sufficient clearance from heat sources, at least 6" for air springs and air lines. If a heat shield was included in the kit, install it. If there is no heat shield, but one is required, call Air Lift customer service at **(800) 248-0892**.

- Fastener test** — Recheck all bolts for proper torque.

- Road test** — The vehicle should be road tested after the preceding tests. Inflate the springs to recommended driving pressures. Drive the vehicle 10 miles and recheck for clearance, loose fasteners and air leaks.

- Operating instructions** — If professionally installed, the installer should review the operating instructions with the owner. Be sure to provide the owner with all of the paperwork that came with the kit.

POST-INSTALLATION CHECKLIST

- Overnight leak down test** — Recheck air pressure after the vehicle has been used for 24 hours. If the pressure has dropped more than 5 PSI, then there is a leak that must be fixed. Either fix the leak yourself or return to the installer for service.

- Air pressure requirements** — It is important to understand the air pressure requirements of the air spring system. Regardless of load, the air pressure should always be adjusted to maintain adequate ride height at all times while driving.

- Thirty-day or 500-mile test** — Recheck the air spring system after 30 days or 500 miles, whichever comes first. If any part shows signs of rubbing or abrasion, the source should be identified and moved, if possible. If it is not possible to relocate the cause of the abrasion, the air spring may need to be remounted. If professionally installed, the installer should be consulted. Check all fasteners for tightness.

Product Use, Maintenance and Servicing

Minimum Recommended Pressure	Maximum Air Pressure
5 PSI	100 PSI

MAINTENANCE GUIDELINES

NOTE

By following the steps below, vehicle owners will obtain the longest life and best results from their air springs.



CAUTION

1. Check air pressure weekly.
2. Always maintain normal ride height. Never inflate beyond 100 PSI.
3. If the system develops an air leak, use a soapy water solution (1/5 liquid dish soap and 4/5 water) to check all air line connections and the inflation valve core before deflating and removing the air spring.

FOR SAFETY AND TO PREVENT POSSIBLE DAMAGE TO THE VEHICLE, DO NOT EXCEED MAXIMUM GROSS VEHICLE WEIGHT RATING (GVWR), AS INDICATED BY THE VEHICLE MANUFACTURER. ALTHOUGH THE AIR SPRINGS ARE RATED AT A MAXIMUM INFLATION PRESSURE OF 100 PSI, THE AIR PRESSURE ACTUALLY NEEDED IS DEPENDENT ON LOAD AND GVWR.

4. Loaded vehicles require at least 25 PSI. A “loaded vehicle” refers to a vehicle with a heavy bed load, a trailer or both. Never exceed GVWR, regardless of air spring, air pressure or other load assist. The springs in this kit will support approximately 40 pounds of load (combined on both springs) for each 1 PSI of pressure. The required air pressure will vary depending on the state of the original suspension. Operating the vehicle below the minimum air spring pressure will void the Air Lift warranty.
5. When increasing load, always adjust air pressure to maintain normal ride height. Increase or decrease pressure from the system as necessary to attain normal ride height for optimal ride and handling. Remember that loads carried behind the axle (including tongue loads) require more leveling force (pressure) than those carried directly over the axle.
6. Always add air to springs in small quantities, checking the pressure frequently.
7. Should it become necessary to raise the vehicle by the frame, make sure the system is at minimum pressure (5 PSI) to reduce the tension on the suspension/ brake components. Use of on-board leveling systems do not require deflation or disconnection.
8. Periodically check the air spring system fasteners for tightness. Also, check the air springs for any signs of rubbing. Realign if necessary.
9. On occasion, give the air springs a hard spray with a garden hose to remove mud, sand, gravel or other debris.

TUNING THE AIR PRESSURE

Pressure determination comes down to three things — level vehicle, ride comfort and stability.

1. Level vehicle

If the vehicle's headlights are shining into the trees or the vehicle is leaning to one side, then it is not level (Fig. 26). Raise the air pressure to correct either of these problems and level the vehicle.

2. Ride comfort

If the vehicle has a rough or harsh ride it may be due to either too much pressure or not enough (Fig. 27). Try different pressures to determine the best ride comfort.

3. Stability

Stability translates into safety and should be the priority, meaning the driver may need to sacrifice a perfectly level and comfortable ride. Stability issues include roll control, bounce, dive during braking and sponginess (Fig. 28). Tuning out these problems usually requires an increase in pressure.

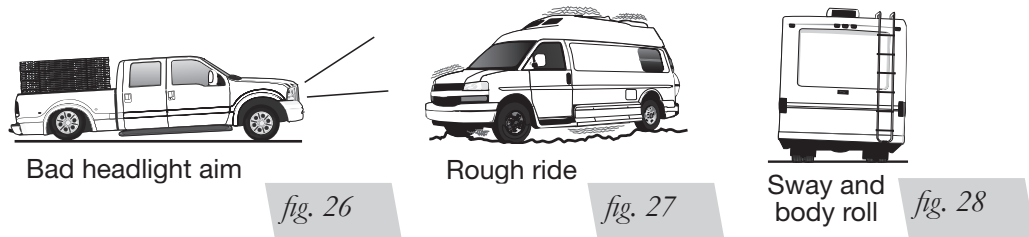

GUIDELINES FOR ADDING AIR

1. Start with the vehicle level or slightly above.
2. When in doubt, always add air.
3. If the front of the vehicle dives while braking, increase the pressure in the front air bags, if equipped.
4. If it is ever suspected that the air bags have bottomed out, increase the pressure (Fig. 29).
5. Adjust the pressure up and down to find the best ride.
6. If the vehicle rocks and rolls, adjust the air pressure to reduce movement.
7. It may be necessary to maintain different pressures on each side of the vehicle. Loads such as water, fuel, and appliances will cause the vehicle to be heavier on one side (Fig. 30). As much as a 50 PSI difference is not uncommon.

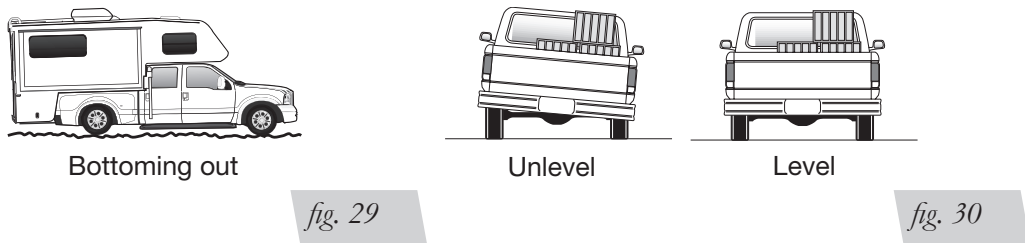

Troubleshooting Guide

PROBLEM	CAUSE	SOLUTION
System won't maintain pressure overnight.	Improperly installed air line, air line has holes or cracks.	Leak test the air line connections, the threaded connection into the air spring, and all fittings in the control system.
Air spring or air line leak.	Fitting seal or air line is compromised.	Check to make sure air lines are seated in connectors. Inspect fittings with soapy water. Trim hose or re-seal fitting. Ensure lines are cut straight.
Corner won't raise or air leak develops.	Look for a kink or fold in the air line.	Replace any air line that has been kinked.

FREQUENTLY ASKED QUESTIONS

Q. Will installing air springs increase the weight ratings of a vehicle?

No. Adding air springs will not change the weight ratings (GAWR, GCWR and/ or GVWR) of a vehicle. Exceeding the GVWR is dangerous and voids the Air Lift warranty.

Q. Is it necessary to keep air in the air springs at all times and how much pressure will they need?

For LoadLifter 5000 Ultimate, the recommended minimum air pressure is 5 PSI, but it can safely be run at zero air pressure unladen (no load).

Q. Is it necessary to add a compressor system to the air springs?

No. Air pressure can be adjusted with any type of compressor as long as it can produce sufficient pressure to service the springs. Even a bicycle tire pump can be used, but it's a lot of work.

Q. How long should air springs last?

If the air springs are properly installed and maintained they can last indefinitely.

Q. Will raising the vehicle on a hoist for service work damage the air springs?

No. The vehicle can be lifted on a hoist for short-term service work such as tire rotation or oil changes. However, if the vehicle will be on the hoist for a prolonged period of time, support the axle with jack stands in order to take the tension off of the air springs.