

Preparation:

- Disconnect the negative battery terminal. Park the vehicle on level ground and set the emergency brake.
- We recommend reading through the installation instructions in whole before performing the work.
- When button head bolts are being used, install the supplied washer on the nut side. Then, hold the bolt stationary and only turn the nut to tighten. Do not turn the bolt to tighten hardware assembly, unless otherwise noted.
- Estimated Installation Time: **3 Hours for OEM Removal/Bumper Installation**

1 Additional Hour to Wire Center Lights

1 Additional Hour to Wire Side Lights

****This installation requires 2 people for best results****

****Labor Rates are based on a vehicle with no pre-existing damage. Wiring labor is based on a standard wiring procedure with light switches installed in an easily accessible location. Custom light triggering or switch mounting location will result in a greater labor charge.****

You will need the following tools:

- | | | |
|--------------------|-------------------------|-----------------------------|
| - Ratchet | - 3/4" Socket & Wrench | - 7/32" Allen Wrench/Socket |
| - 7mm Socket | - 10mm Socket | - 13mm Socket |
| - 15mm Socket | - 17mm Socket | - 18mm Socket & Wrench |
| - Utility Knife | - 7/16" Socket & Wrench | - 9/16" Wrench |
| - T-10 Torx Socket | | |

Included in Kit:

- | | |
|---|---|
| 8 - Hex Head Bolts (M10-1.5 x 30mm) | 8 - Flat Washers (M10) |
| 2 - Black Button Head Bolts (1/2"-13 x 1 1/2") | 2 - Black Washers (1/2") |
| 2 - Nylon Lock Nuts (1/2"-13) | 2 - Hex Head Bolts (3/8"-16 x 1") |
| 2 - Black Button Head Bolts (3/8"-16 x 1") | 2 - Flat Washers (3/8") |
| 4 - U-Nuts (3/8-16) | 2 - Hex Head Bolts (1/4"-20 x 3") |
| 8 - Flat Washers (1/4") | 6 - Hex Nuts (1/4"-20) |
| 2 - 2" Section of Rubber Tubing (1/4" ID) | 1 - Shutter Motor Bracket (2 Pieces) |
| 2 - Bumper Mounting Brackets | 4 - Parking Sensor Plugs |
| 4 - Grommets for Parking Sensor Plugs | |

Also Included with Dual 20" Version:

- | | |
|---|--|
| 4 - Black Button Head Bolts (3/8"-16 x 1") | 4 - Flat Washers (3/8") |
| 4 - Nylon Lock Nuts (3/8-16) | 2 - Light Mount Brackets (Set of 2) |

Removal:

1. Using a T-10 Torx Socket, remove the three inner fender liner bolts referenced in (Fig A).



Fig A

2. Pull the front part of the fender flare back. There are no tools required for this step, they simply pull free by hand. Then remove the 7mm bolt that was hidden behind the fender flare. (Fig B)



Fig B

2020-Current Chevy 2500/3500 Bomber™
Front Bumper Installation Instructions

3. Pull the valance off the vehicle. There are no tools required for this step, it simply pulls off by hand. (Fig C)



Fig C

4. Repeat Steps 1-3 on the other side of the vehicle.
5. Pop the hood. Then, use a T-10 Socket to remove the two bolts holding on the outer portion of the hood latch handle. Remove the outer portion of the hood latch handle. (Fig D)



Fig D

6. Remove the plastic clips (x9) that hold on the radiator cover. Then, remove the radiator cover from the vehicle. (Fig E)

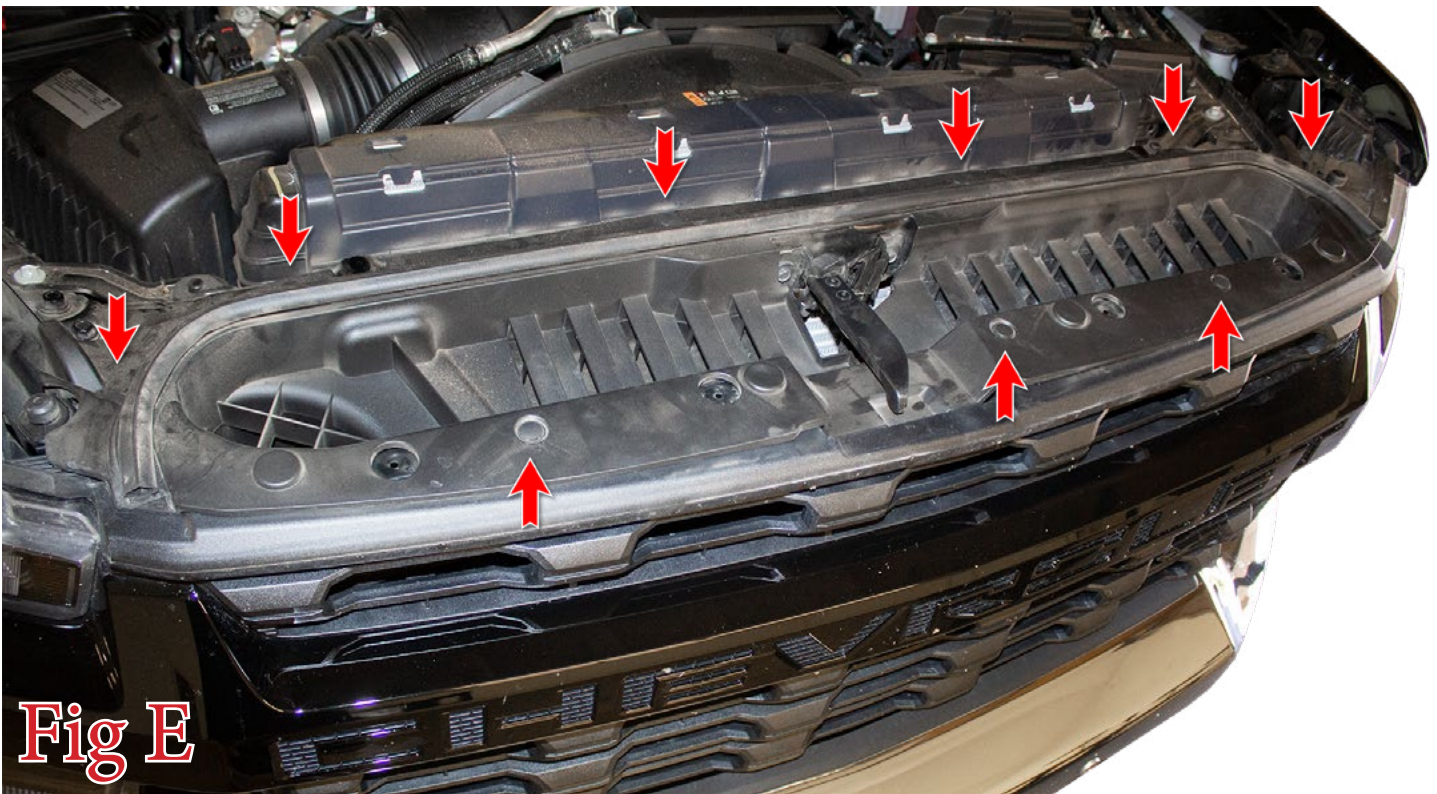

7. Use a 10mm Socket to remove the upper grille bolts (x4). (Fig F)



8. Use a 10mm Socket to remove the lower grille bolts (x2). Then, remove the grille from the vehicle. After the bolts are removed, the grille will pull off by hand. (Fig G)



9. On the passenger side of the vehicle, unplug the connector below the headlight. (Fig H)

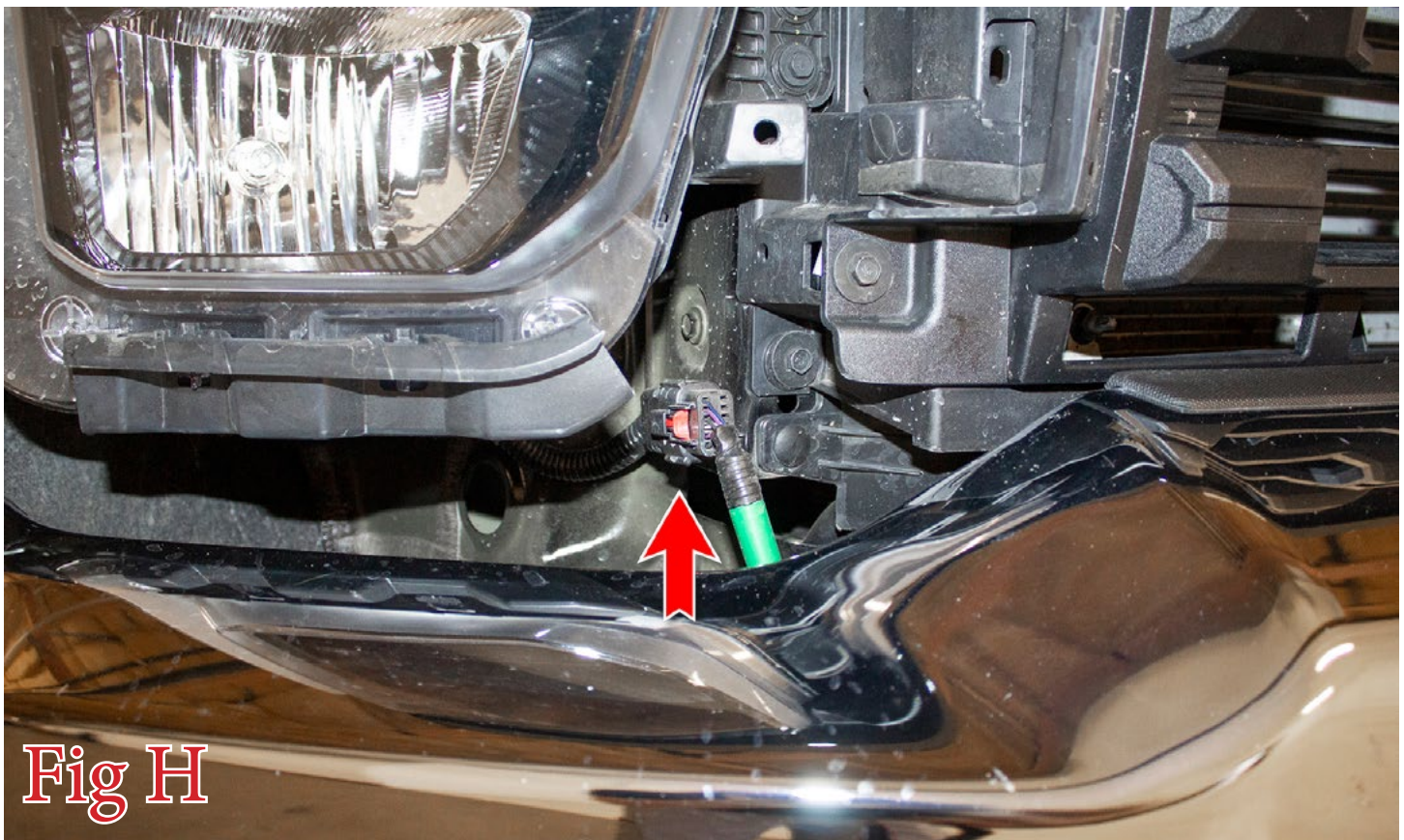

2020-Current Chevy 2500/3500 Bomber™
Front Bumper Installation Instructions

10. On the driver side of the vehicle, unplug the connector underneath the headlight (if applicable). (Fig I)

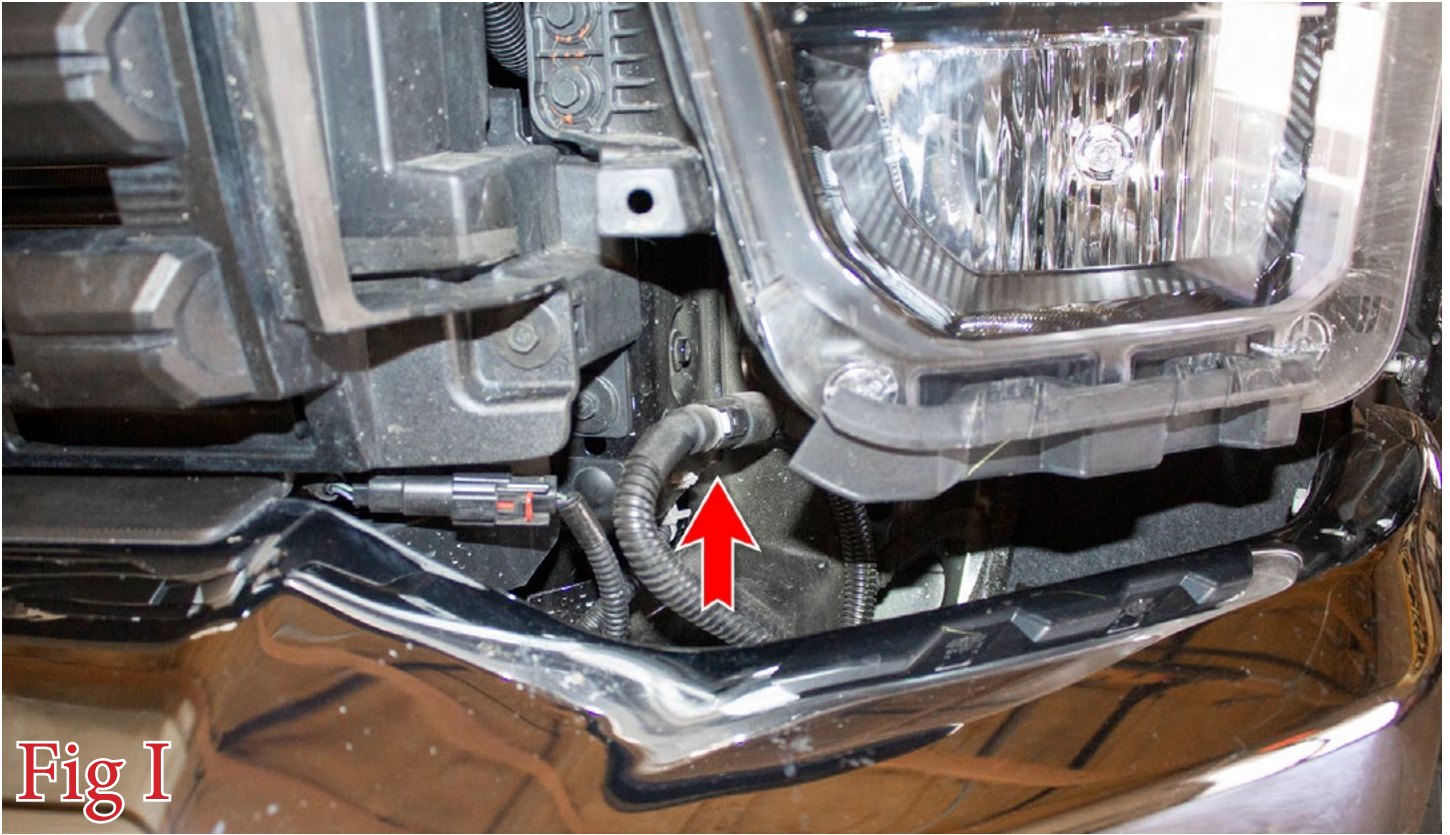

11. From underneath the vehicle, use a 15mm Socket to remove the bumper side support bar bolts referenced in (Fig J).



12. Looking down from the top of the bumper, there are two mounting bolts per side. Use an 18mm Socket to remove these four bolts. Then, remove the OEM bumper from the vehicle. (Fig K)



13. Use an 18mm Socket & Wrench to remove the tow hook mounting bolts (2 per hook). Then, remove the tow hooks from the vehicle. (Fig L)

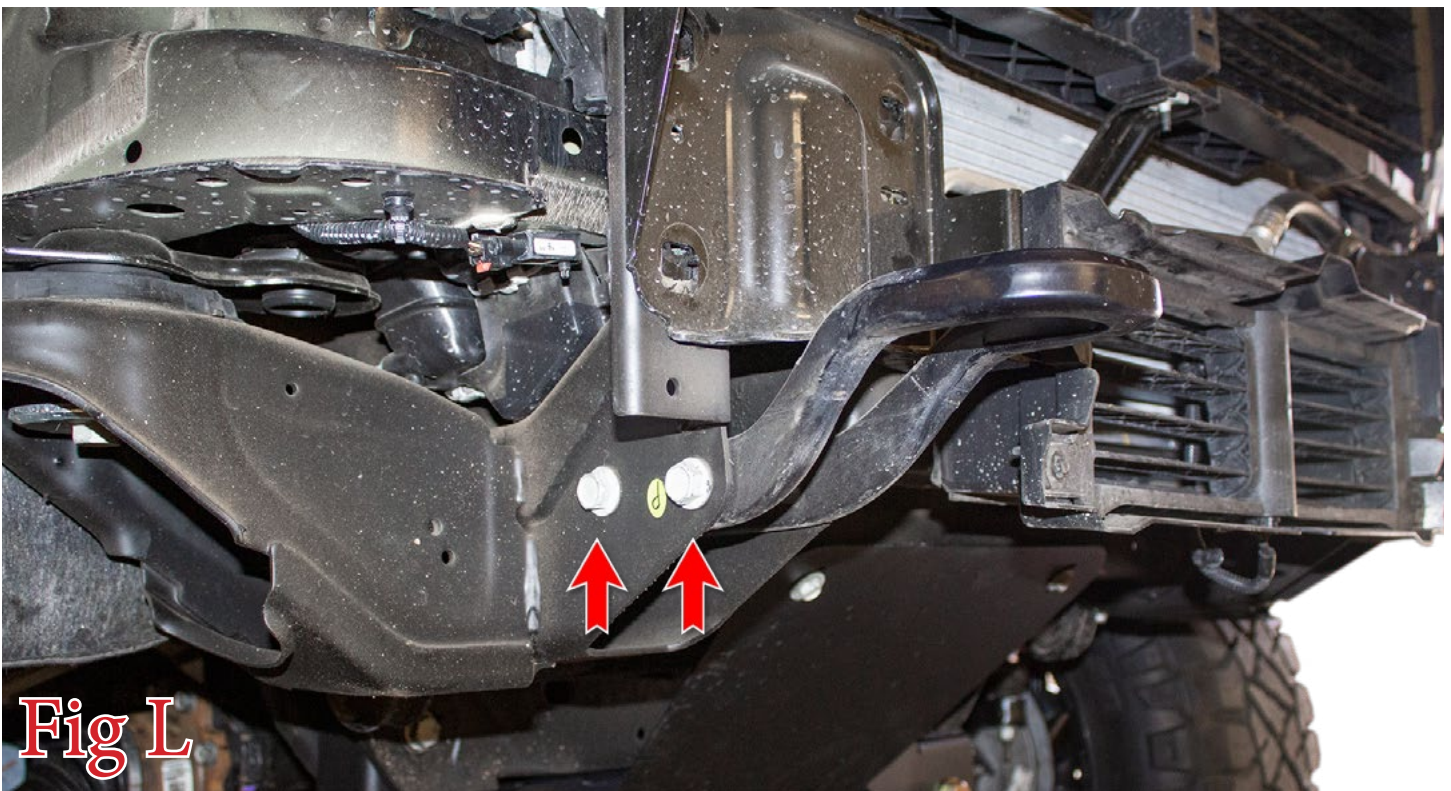

14. Unplug the connector on the bottom side of the intercooler shutter system. (Fig M)



Fig M

15. Release the 4 plastic clips holding the shutter motor harness to the plastic scoop. (Fig N)

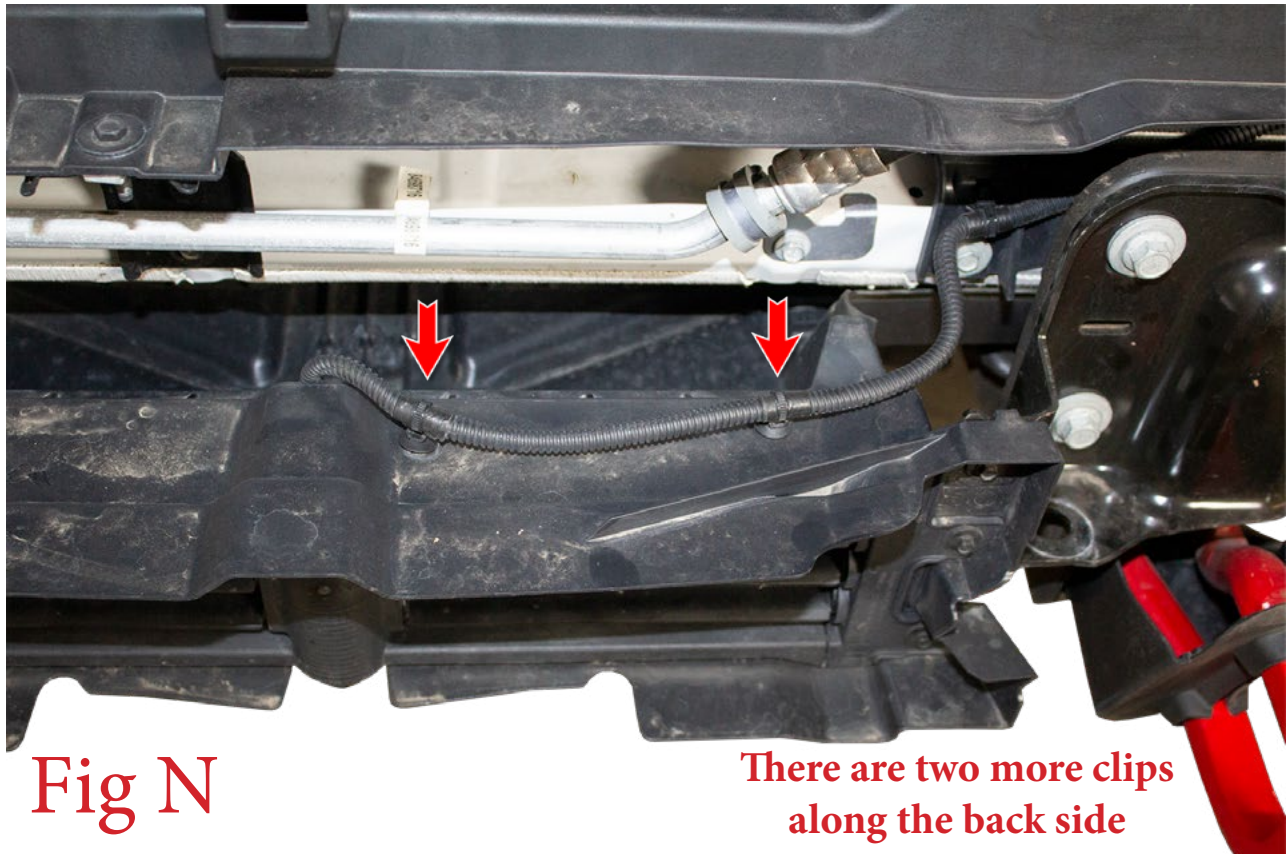

Fig N

**There are two more clips
along the back side**

16. Use a 15mm Socket to remove the 8 bolts that hold the bumper bracket/intercooler scoop assembly to the vehicle. Then, remove the scoop/bracket. (Fig O)

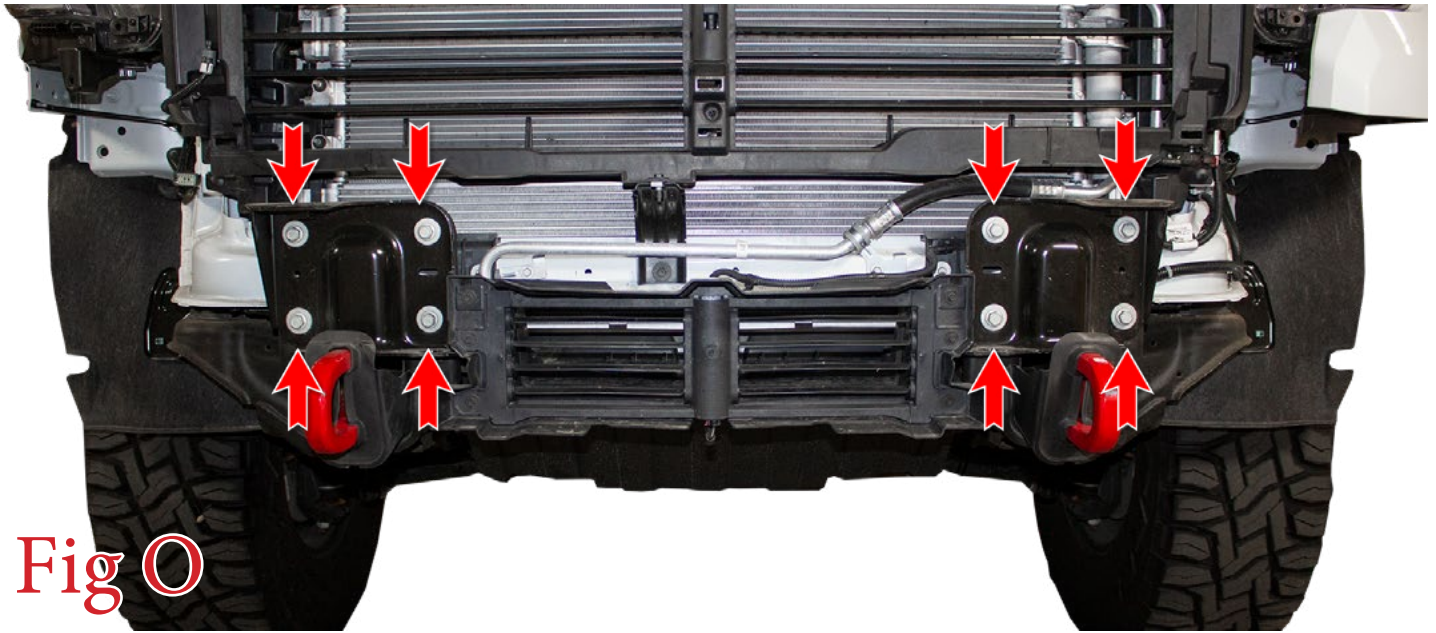

Fig O

17. Using a 7mm Socket, remove the bolts mounting the intercooler scoop to the bumper bracket. Then, separate the scoop from the bracket. (Fig P)



Fig P

18. Undo the two clips (per side) on the scoop assembly. Then, remove the sides and shutters from the scoop assembly. (Fig Q)

**Undo these two clips, along
the two clips on the other
side of the scoop.**

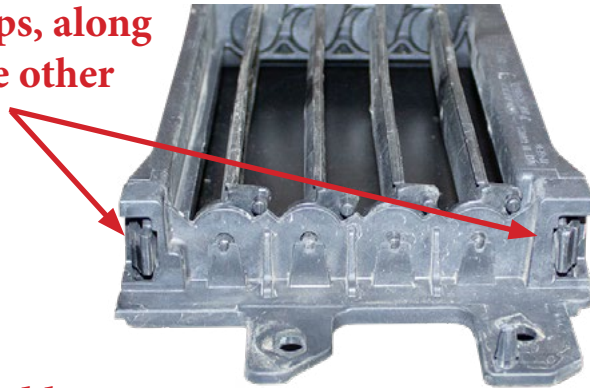

**Your scoop assembly
should now look like this**



Fig Q

19. Remove the shutter motor from the scoop assembly. (Fig R)



Fig R

20. Find the two shutter motor bracket pieces. Then, install the shutter motor into the bracket pieces as shown in (Fig S). **Make sure to use the outer most mounting holes.** Use the supplied 1/4-20 x 3" Bolts (x2), 1/4" Washers (x8), and 1/4-20 Hex Nuts (x6). As you are putting this together, install the supplied rubber tubing onto the bolts.

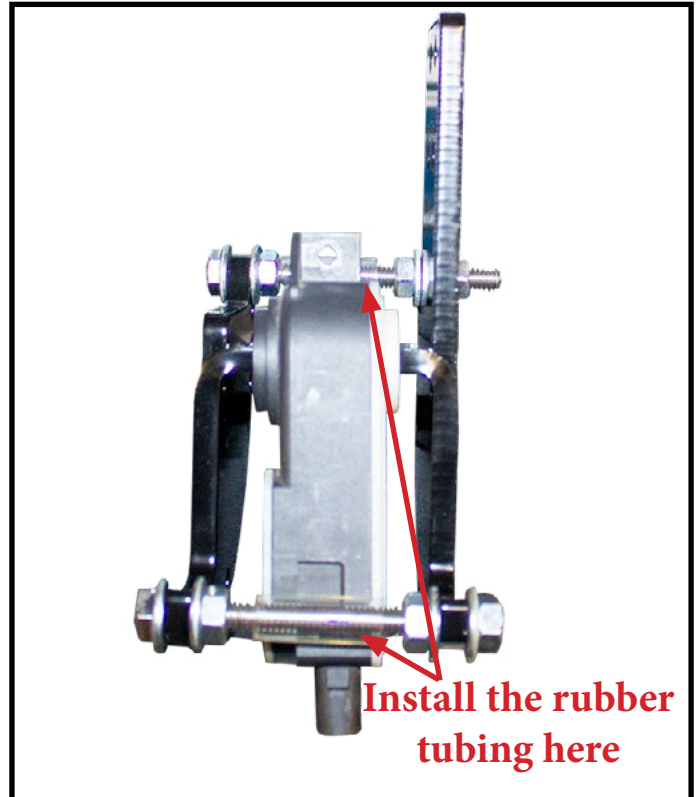
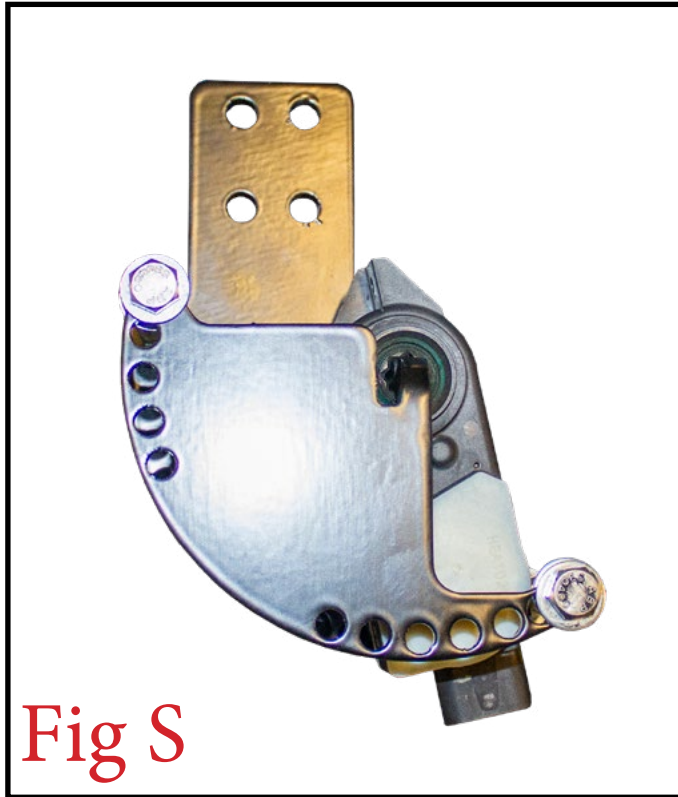

21. On the driver side of the remaining portion of the intercooler scoop, use a utility knife, or something similar, to trim off the corner following the guide shown in (Fig T).



Cut Along this
Line

22. Remove the bolt referenced in (Fig U). Then, put the shutter motor/bracket assembly in place as shown and reinstall that bolt. **The motor will swing within the range of the two mounting bolts. Make sure the wiring is zip tied out of the way, but also allows the shutter motor to move as needed.**



23. Reinstall the valances/grille by reversing Steps 1-8. (Fig V)

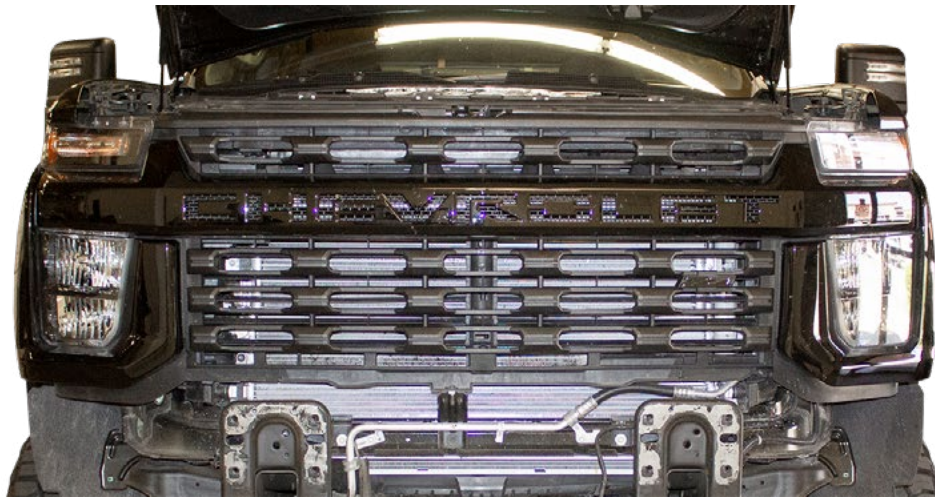
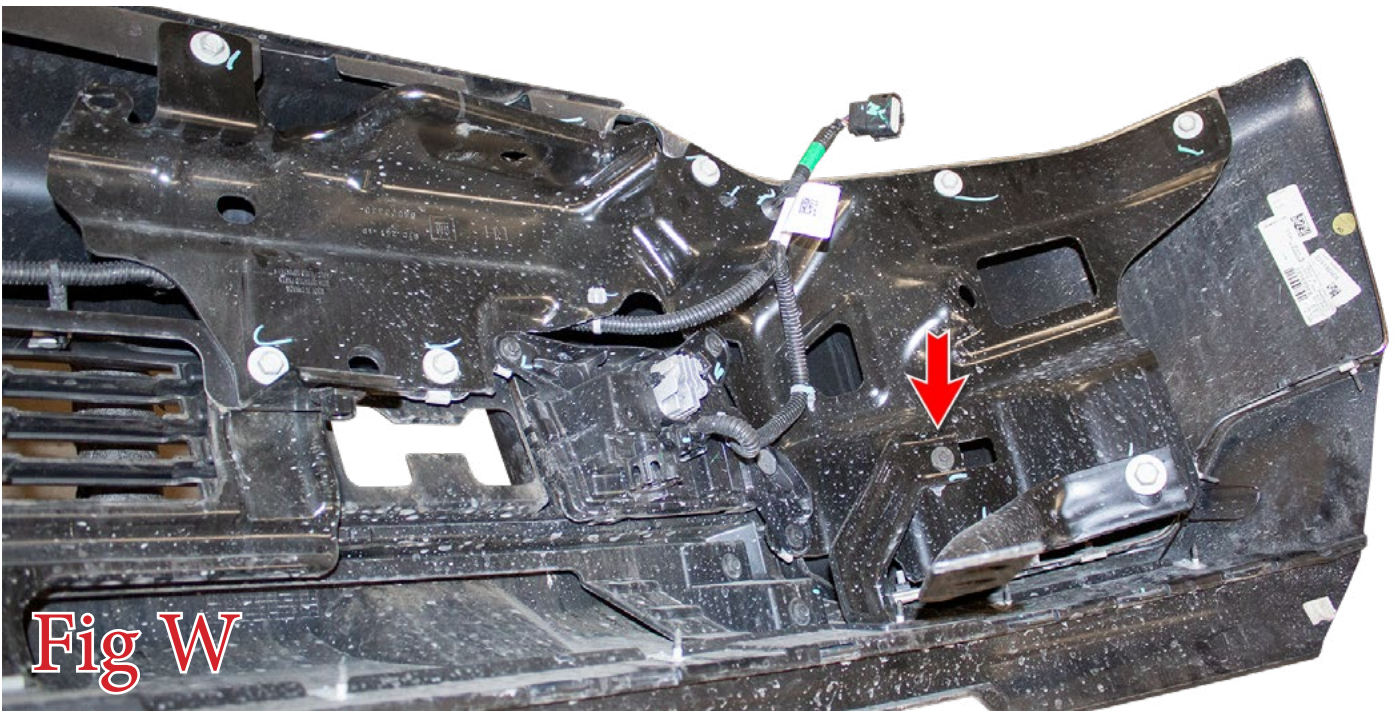
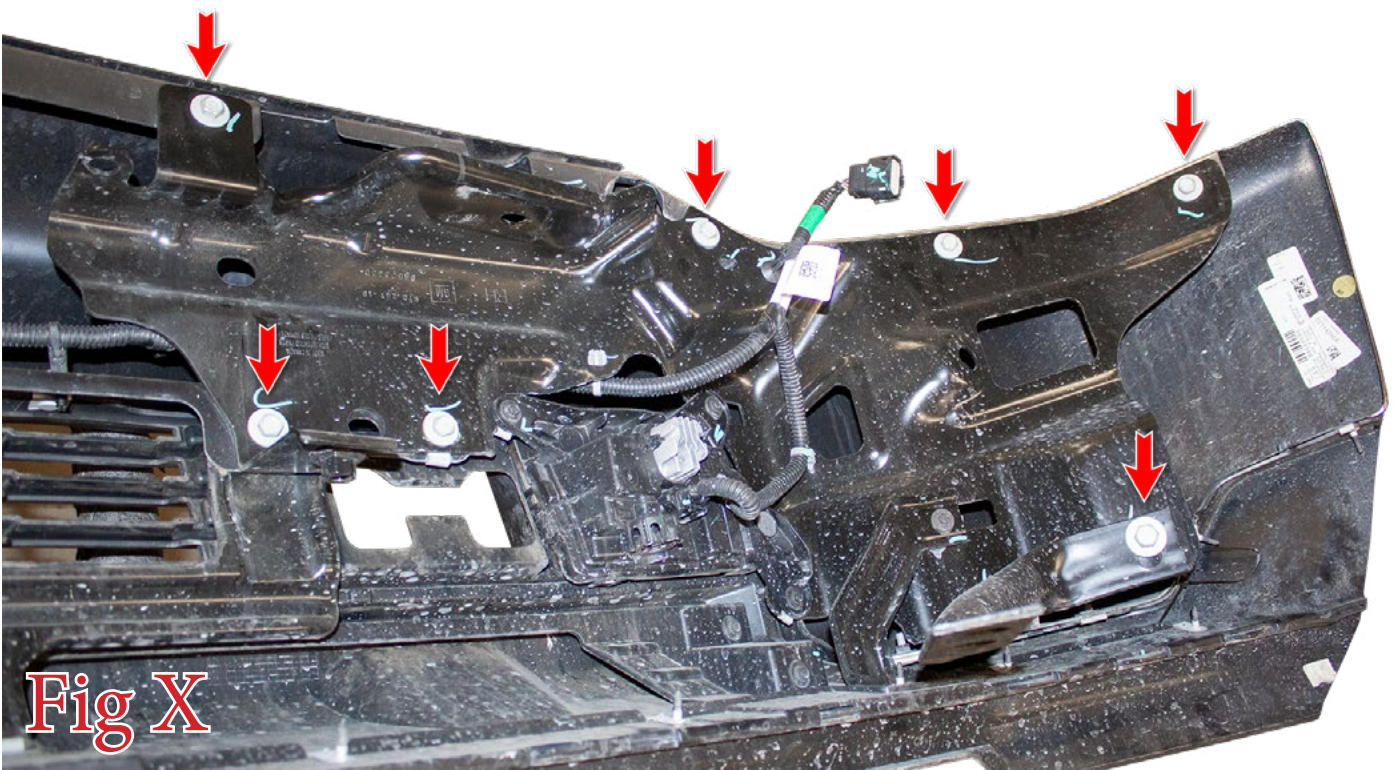

Fig V

24. With the OEM bumper on a workbench, remove the 7mm bolt (1 per side) that holds the inner structure to the bumper. (Fig W)



25. Use a 13mm Socket to remove the mounting bolts (7 per side) that hold in the inner metal structure of the bumper. Then, remove this structure. (Fig X)



26. Remove the parking sensors from their mounting rings. Do this by spreading the two tabs on the back side of the mounting rings and pushing the sensors out the back of the rings. You can leave the sensors plugged into the harness. **Make sure to keep track of what position/orientation the sensors were mounted in so you can keep the same position/orientation on your new bumper.** (Fig Y)

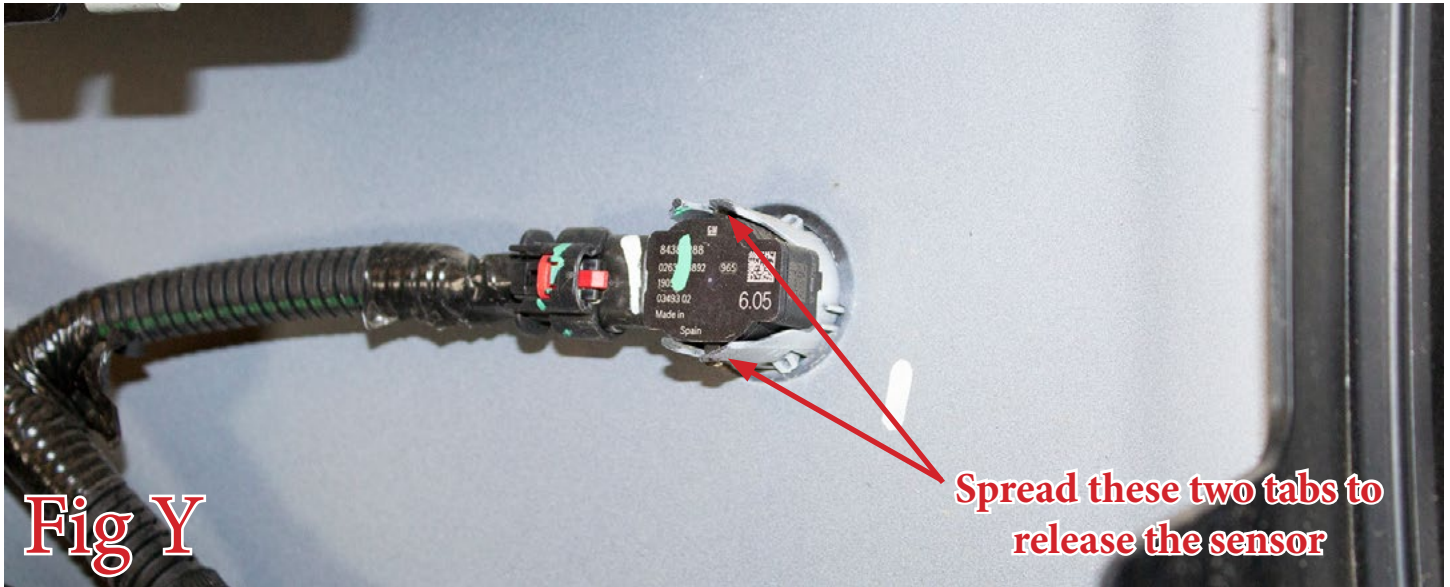

27. Remove the sensor mounting rings from the bumper. Do this by pressing in the tabs on the back side of the rings and pushing the rings out the front side of the bumper. **Make sure to keep track of the position/orientation that these came off the OEM bumper so they can be reinstalled on your new bumper in the same position/orientation.** (Fig Z)

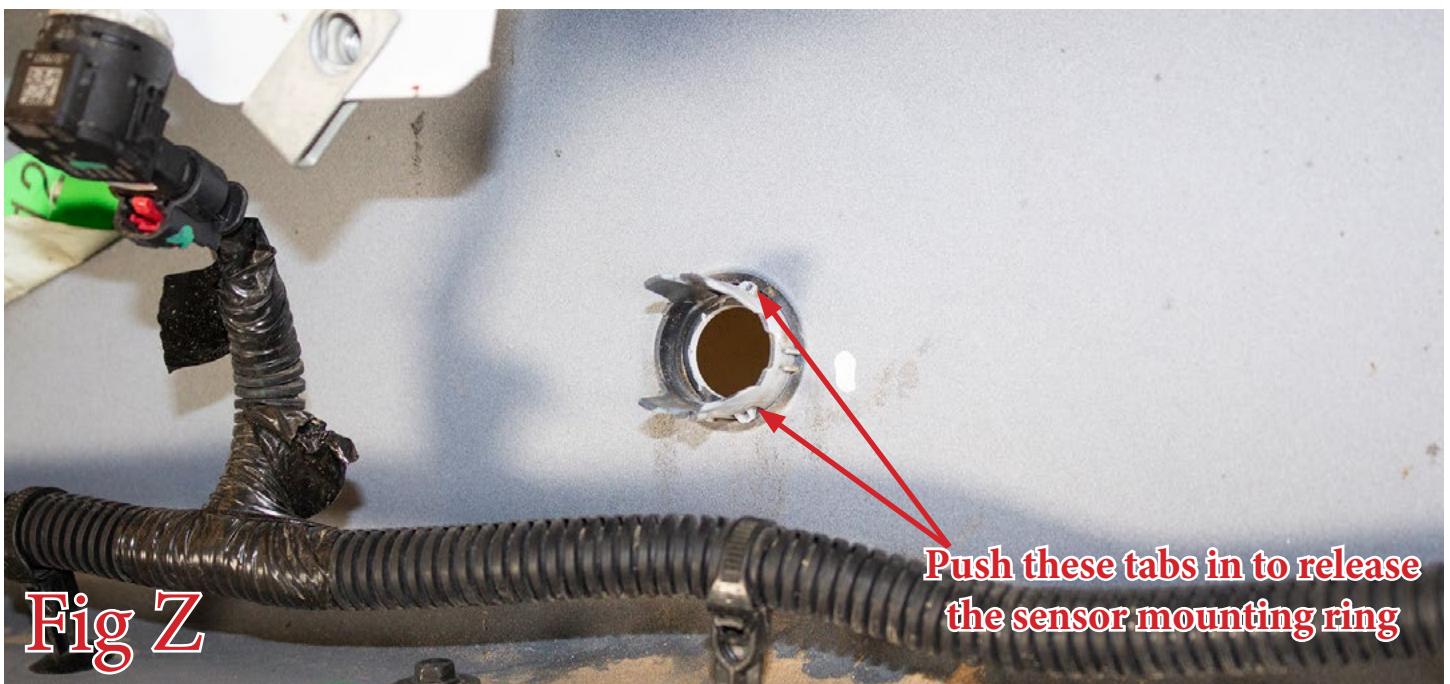

28. Release the series of clips holding the harness to the bumper. Then remove the parking sensor/fog light harness from the bumper. (Fig AA) **Make sure to keep track of the position this was mounted on the OEM bumper so it can be mounted on your new bumper in the same position.**



Fig AA

Installation:

29. Install the Parking Sensor Mounting Rings onto your new bumper. Install them in the same position/orientation as they came off the OEM bumper. If they do not fully click into their holes, you will have to trim back the tabs that hold them in place to account for the thicker material of your new bumper. Do this little at a time, so you don't go too far. (Fig AC) Once the mounting rings are in place, push the parking sensors into the mounting rings from the back side. **Make sure to install the rings and sensors in the same position/orientation as they came off the OEM bumper.**

**You may have to
file these surfaces
back a little.**

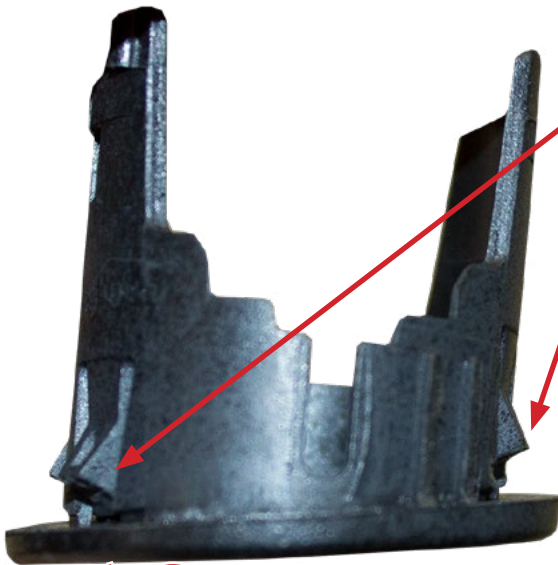
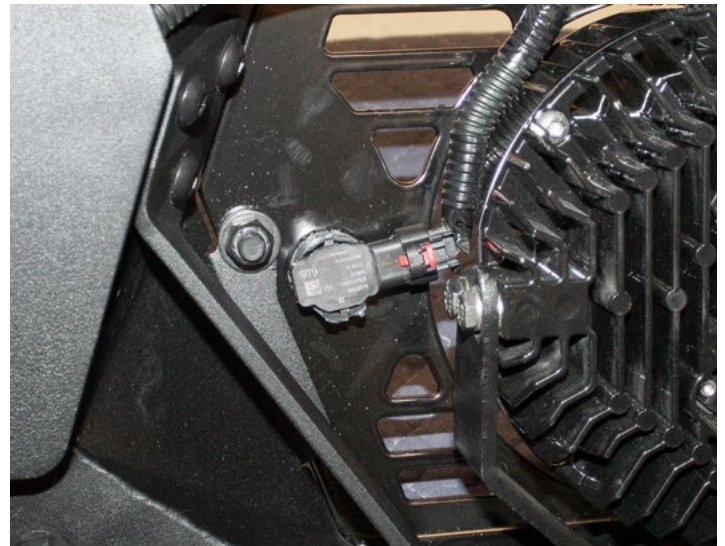

Fig AC



30. Find the supplied Bumper Mounting Brackets. Set them in place on the vehicle. Then, use a 17mm Socket to install the supplied M10 Bolts (4 per side) and M10 Washers (4 per side). Once all bolts are loosely installed, torque the M10 Bolts to 40 foot pounds. (Fig AB)

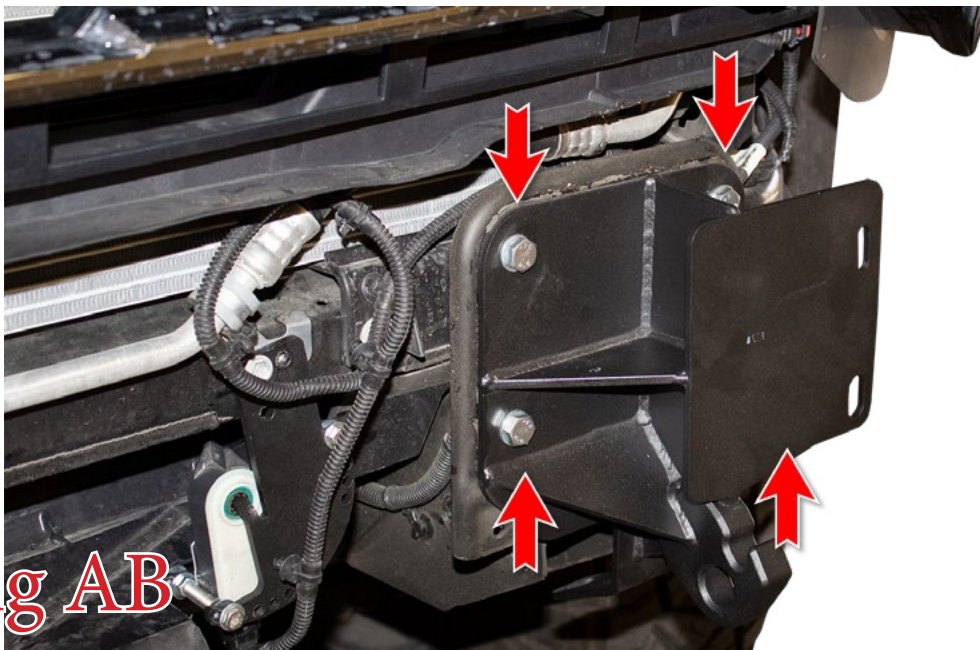

Fig AB

31. If you have the dual 20" light bar version of this bumper, follow this step. If not, skip this step. Use the supplied 3/8" Button Bolts (x4), 3/8" Washers (x4), and 3/8" Lock Nuts (x4) to loosely install the onto the bumper. Then, install the light bars using the hardware supplied by the light manufacturer. Once all bolts are loosely installed, tighten the light manufacturer's hardware to their torque spec. Tighten the 3/8" Button Head Bolts to 30 foot pounds. The final product will look like (Fig AD).

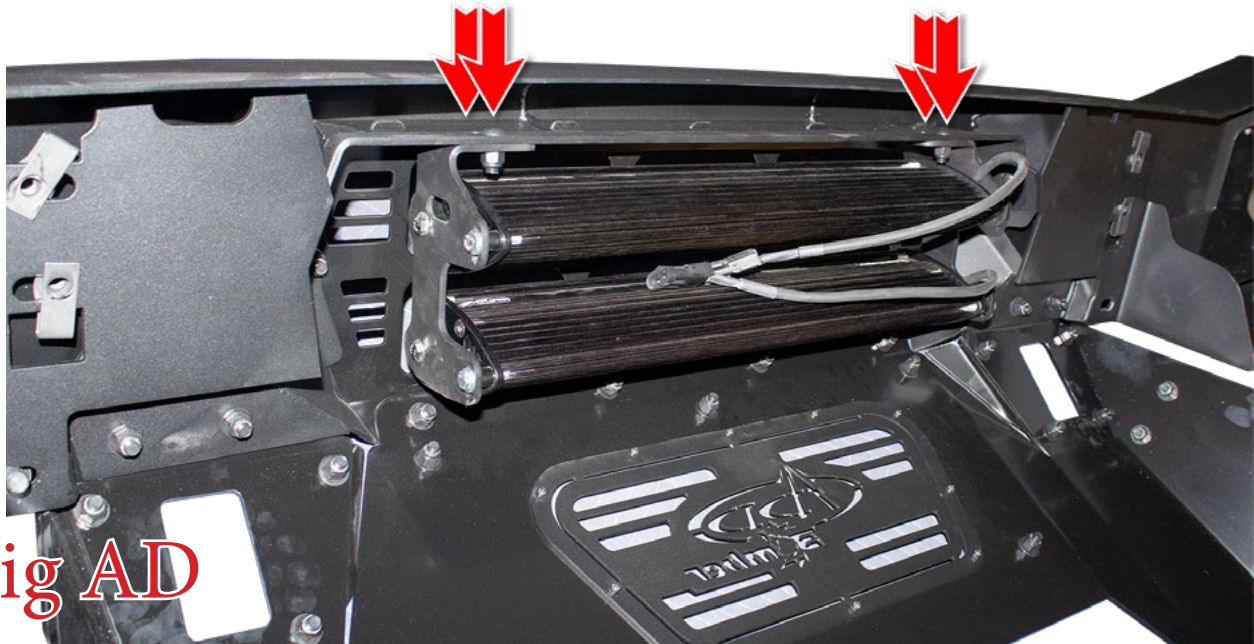

Fig AD

32. If you have the Baja LP6 version of this bumper, follow the next 3 steps. If not, skip to Step 35. Remove the 6 bolts that hold the light bracket to the bumper. Then, remove this bracket from the bumper. (Fig AE)



Fig AE

33. Install your Baja LP6 lights using the light manufacturer's mounting hardware. (Fig AF)



Fig AF

34. Reinstall your light bracket onto the bumper by reversing Step 32.
35. If you have the Rigid 360 Series version of this bumper, you can install your lights onto the bumper without removing the light bracket. You may also install your cube lights onto the side pods of your bumper at this time.
36. Install the supplied U-Nuts (1 per side) onto the bumper as shown in (Fig AG).

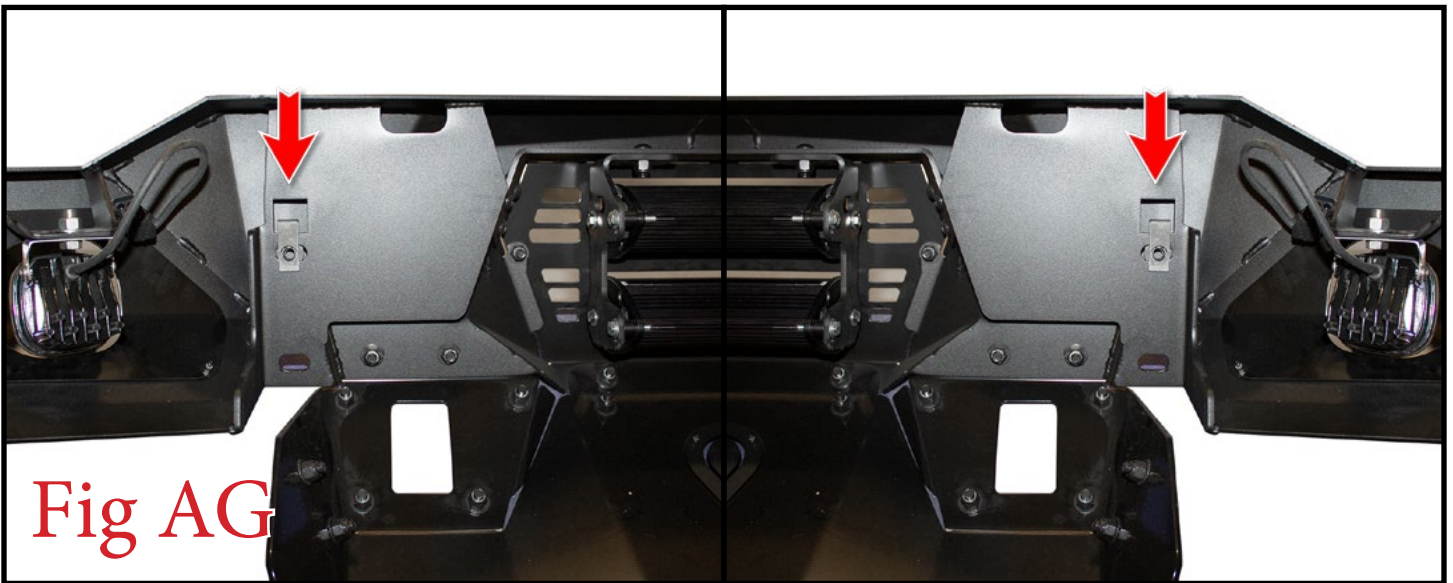

37. Install one of the supplied U-Nuts onto each bumper mounting bracket as shown in (Fig AH).

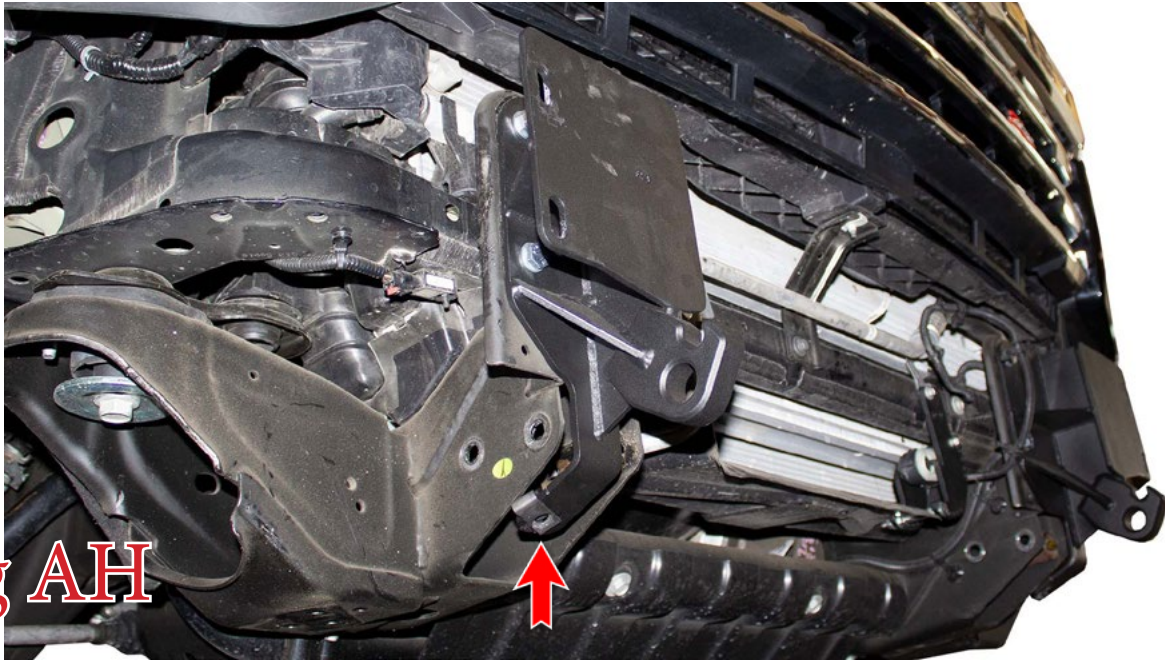

Fig AH

38. Set the bumper in place on the vehicle. Then, loosely install the supplied 3/8" Hex Head Bolts (1 per side) and 3/8" Washers (1 per side) from the back side of the vehicle's frame horns (you will have to access this through the side pod light opening in the bumper). Then, install the supplied 1/2" Black Button Head Bolts (1 per side), 1/2" Black Washer (1 per side) and 1/2" Black Lock Nut (1 per side) in the lower mounting hole on the frame horn. Leave these bolts loose for now. (Fig AI)

View Looking In From The Side Pod

View From The Front

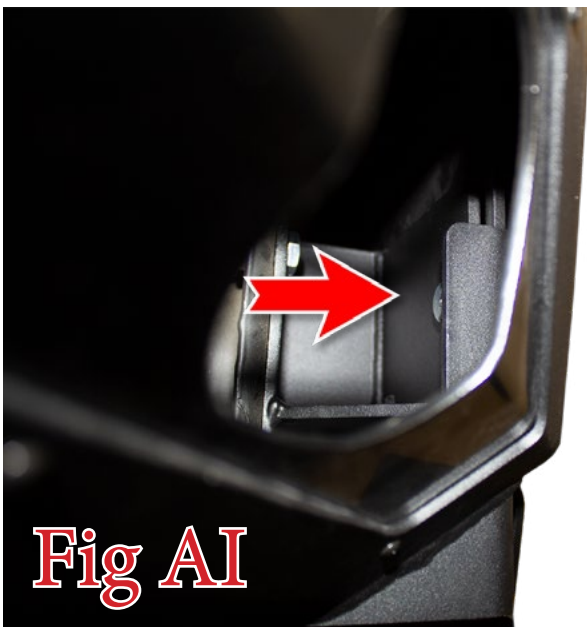

Fig AI



2020-Current Chevy 2500/3500 Bomber™
Front Bumper Installation Instructions

39. Install the supplied 3/8" Button Head Bolts (1 per side) into the skid plate mounting holes on the bumper. Leave these bolts loose for now. (Fig A)

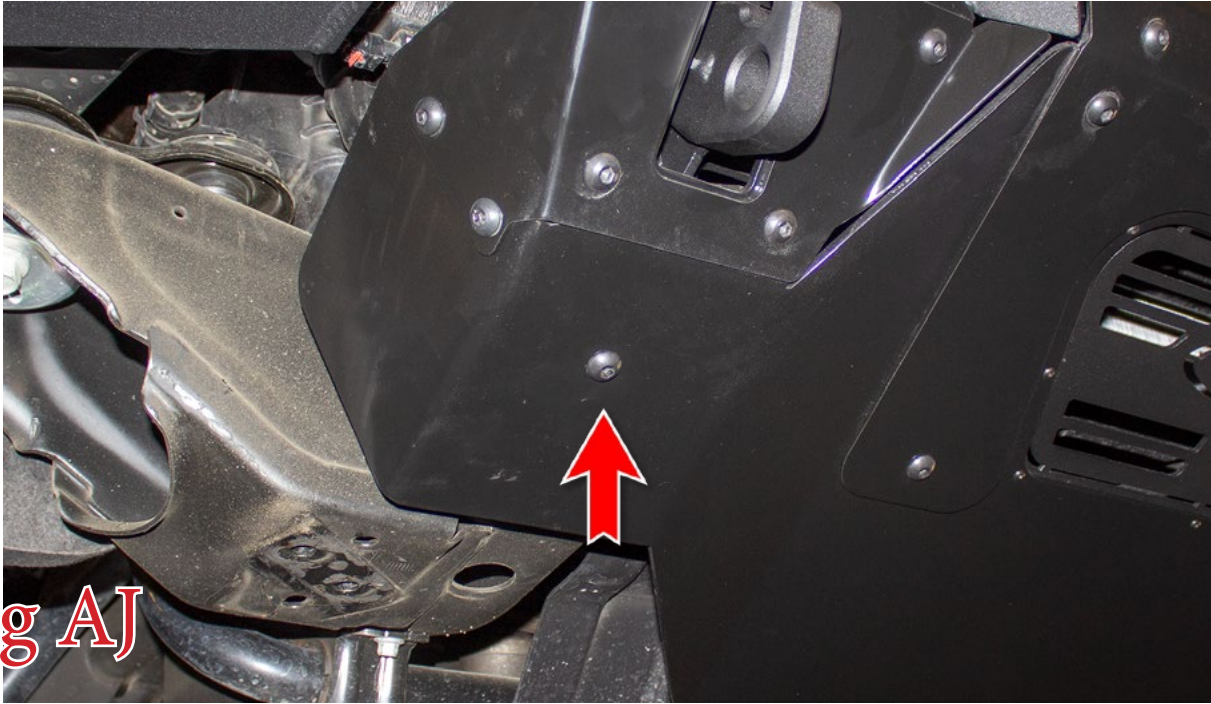

Fig A

40. Align your bumper so it is centered left to right and straight in relation to the grille/valance. Then, tighten the 3/8" Mounting Bolts from Step 38 to 25 foot pounds. Tighten the 1/2" Mounting Bolts from Step 38 to 70 foot pounds. Then, tighten the 3/8" Mounting Bolts from Step 39 to 25 foot pounds.

41. Use a T-10 Socket to remove the two lowest inner fender liner bolts in each wheel well. (Fig AK)



Fig AK

42. Pull the inner fender liner back to reveal the two bolts holding on the inner liner mounting bracket. Use a 10mm Socket to remove these bolts. Then, remove that bracket from the vehicle. (Fig AL)



Fig AL

43. Use a utility knife, or something similar, to trim the inner fender liners to preference. We suggest following a line similar to what is shown in (Fig AM).



Fig AM

44. Install the cube lights into the side pods of the bumper. Follow the light manufacturer's guide for mounting/wiring information.
45. Stand back and enjoy your new ADD Bomber™ Front Bumper.
46. Check and re-tighten, if needed, all mounting bolts after 100 miles and periodically thereafter.

2020-Current Chevy 2500/3500 Bomber™
Front Bumper Installation Instructions

